

Plastics Industry Sensors



Technical Data

Plastics Sensors Construction

Introduction

The typical plastics industry sensor assembly consists of four components:

- attaching device,
- element,
- element protection,
- cold end termination.

The sensor is further defined by its physical attributes:

- number of elements
- junction style (hot end)
- probe configuration (straight, 45°, 90°)
- length of components

The following paragraphs provide a brief explanation of each component and physical attribute. After reading this section you should have a general, comprehensive understanding of how sensors for the plastics industry are constructed.

Components

Attaching Device

Some sensors are designed for specific applications and have a unique attaching device; others are designed for general application and have a common attaching device.

The attaching device, also called the process mount, is defined by the way it mounts the sensor to the workpiece. The following paragraphs discuss the various devices. For detailed explanation, see "Process Mounting."

Unique mounts include

- melt bolt
- nozzle melt
- ring or lug

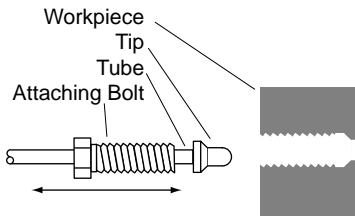

The melt bolt sensor is used on extruders and injection molding machines. A melt bolt "blank" with a hole through its length is welded to the rigid tube.

The nozzle melt sensor is designed for injection molders. Two types are available: immersion type and non-immersion type. The immersion type is a bolt "blank" with a hole through its length on the sensor tube. The sensor tip protrudes through the workpiece and seats in a beveled hole in the work piece. The attaching bolt is threaded into the workpiece and tightly seals the tip to the workpiece.

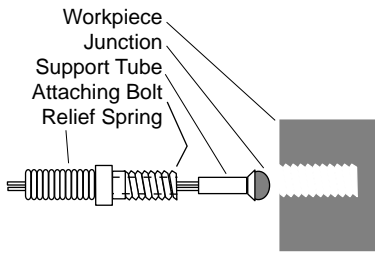

The non-immersion type is an attaching bolt with a center hole. A short tube seats in the bolt hole and supports the thermocouple junction against the bottom of the hole in the workpiece. Or, if the sensor is an RTD, the tip is potted in the hole in the bolt.

Ring type and lug type sensors measure surface temperature – such as a barrel or a mold. The sensor leads are joined at the ring or lug (hot junction). The sensor attaches to a threaded stud on the workpiece and must be secured with a nut.

Nozzle Melt Sensors

Technical Data

Components (continued)

General application sensors are commonly called tube style sensors and are mounted with:

- bayonet lock, or
- threaded bushing.

These devices are secured to the rigid tube portion of the sensor assembly.

Varidepth® sensors have no rigid tube (other than the tip). The element of a Varidepth sensor is protected by either a flexible tube or spring. Both of these components are compressible. Varidepth sensors are equipped with a bayonet style lock cap directly on the tube or spring.

Two types of bayonet locks are available: fixed or adjustable. The fixed bayonet lock is secured to the tube between two rings formed on the tube surface. The adjustable bayonet lock is held on the tube with a compression ring and nut.

Two types of threaded bushing mounts are available: fixed or adjustable. However, the more common, by far, is the adjustable bushing held on the tube with a compression ring and nut. The fixed bushing is brazed to the tube.

Both the Varidepth sensor and the bayonet lock require a mating adapter to mount it to the workpiece. The threaded bushing mounts directly into a tapped hole in the workpiece.

Element

The thermocouple element is defined by its calibration (type), wire size (gauge), construction (solid, strand, insulation). The resistance temperature detector (RTD) is defined by its resistance coefficient.

Element Protection

Element protection is defined by its construction: rigid tube, flexible armor (or flexible tube), stainless steel overbraid, spring, or insulation only. Rigid length is identified as dimension "X." Flexible length is identified as dimension "Y."

The depth of the fixed bayonet lock attaching device is identified as dimension "Z." Since the location of the bayonet lock on most assemblies (but not all) is near the transition point (from rigid to flexible), the "Z" dimension is equal to the length of the probe. Therefore, there is no "X" dimension.

Cold End Termination

Cold end termination is defined by the device with which the sensor leads are terminated: stripped ends, spade lugs, plug, and/or jack. It is further defined by the extended length of the leads – that is, leads in addition to the standard length normally provided with that sensor. Extended lead length is identified as dimension "L."

Physical Attributes

Number of Elements

Many sensors can accommodate two elements – called dual element. Dual element construction is restricted by wire size and tube size.

Junction Style

Junction style specifies whether the tube end is open or closed, and if the element is grounded to the tube.

Probe Configuration

Specifies the angle of the sensor probe relative to the attaching device. Sensors are available straight in line, or 45° or 90° off the mounting plane.

Length of Components

Components with meaningful linear dimensions are the rigid tube (or probe), flexible tube, including stainless steel overbraid and Fiberglass insulation only, and extended lead

Technical Data

Components (continued)

(considered part of the cold end termination). Code designations for each of these dimensions are as follows:

- X = Rigid length (probe). Typically applies to sensor with adjustable attaching device.
- Y = Flexible length (flexible armor, SS overbraid, Fiberglass)
- Z = Locating depth for fixed bayonet lock. Frequently, but not always, replaces X.
- L = Extended lead. In addition to the standard lead length provided on the sensor.

Process Mounting

The sensor probe can be mounted to the workpiece with any of the following attaching devices. All attaching devices are not applicable to all sensors. Each sensor illustration on the following pages lists only the attaching devices appropriate for that sensor.

Fixed Bayonet

A spring loaded locking cap held in a fixed position on the probe tube between two rings formed ("popped") on the tube surface. The locking cap attaches to an adapter that is mounted to the workpiece. Various adapters are illustrated under "Accessories" at the end of this section.

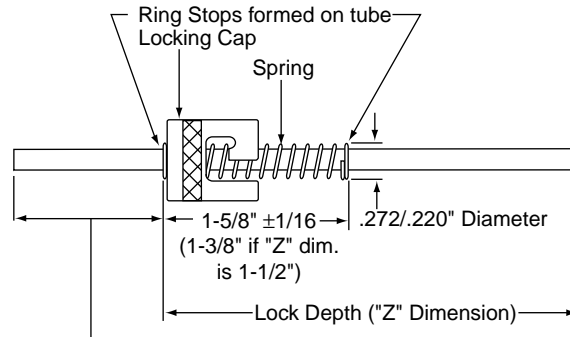

1" for straight probes; 2-3/4" for 45° and 90° probes
(angles bent at final assembly)

Adjustable Bayonet

This device can be fitted over any 1/8" o.d. plain end thermocouple and adjusted to the selected immersion depth by tightening the compression fitting. With a suitable adapter, any immersion depth over 1/2" can be selected.

The fitting is shipped with both a nylon and brass ferrule. Nylon permits readjustment, but should not be exposed to temperature over 250°F. The brass ferrule cannot be adjusted after it is set. It is suitable for temperatures up to 900°F.

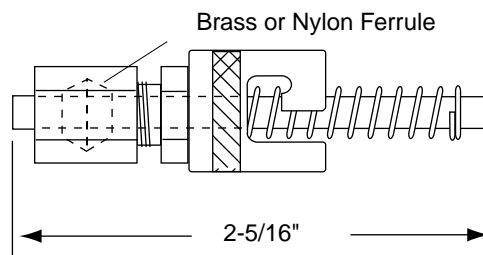

Technical Data

Process Mounting (continued)

Varidepth®, and Spring Style Varidepth

Varidepth is a trade marked mounting device that uses a bayonet type locking cap, and which is applicable to two different styles of thermocouples; flexible armor clad, and spring clad. Each of these protection clads is compressible and therefore provides the pressure needed to hold the thermocouple tip snugly in the workpiece.

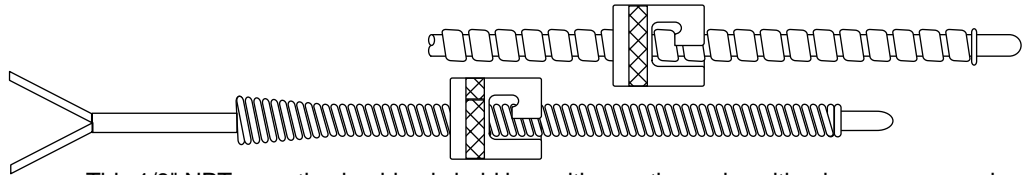

Adjustable Bushing

This 1/8" NPT mounting bushing is held in position on the probe with a brass compression ring secured with a compression nut. Once installed, the compression ring cannot be relocated. The mounting bushing and compression nut are available in nickel plated brass, or stainless steel.

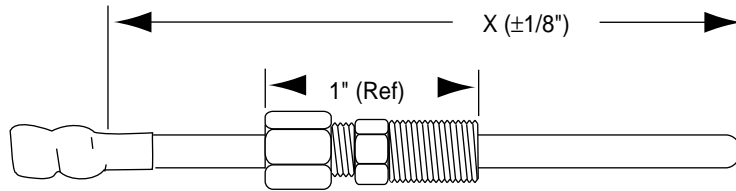

Brazed Bushing

This 1/8" NPT mounting bushing is brazed to the sensor probe at the "U" dimension specified on the order.

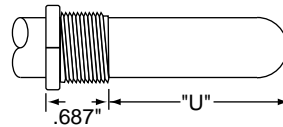

Determining Adapter Length

Threaded Adapter

To determine the nominal adapter length, proceed as follows:

Adapters with 1/8 NPT: "Z" dimension minus hole depth, minus 3/8"

Adapters with 3/8-24 thread: "Z" dimension minus hole depth minus 1/4".

Round the adapter length up to the nearest 1/8".

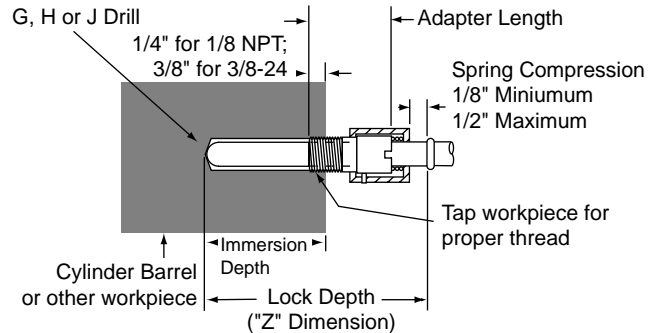

Pipe Clamp Adapter

This adapter can be used with thermocouples with bayonet lock to measure tube or pipe surface temperatures. The thermocouple is in direct contact with the pipe.

The adapter is available with the "L" dimension in 1/2" increments beginning with 1-1/2". The "L" dimension of the adapter should be approximately 9/16" shorter than the "Z" dimension of the probe.

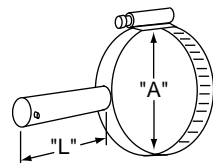

Model Number Breakdown

Anatomy of a Model Number

Introduction

The Barber-Colman model number is made up of fifteen fields. Each field, or series of fields, contains a code, or codes, that represents a specific feature of the product.

This section of the book is devoted to sensors designed primarily for application in the plastics manufacturing industry. Two types of sensors are listed: thermocouples and resistance temperature detectors.

This section tells you how to identify the specifications of a thermocouple from the model number.

Analyzing a Model Number

Field 1

Application – Plastics Industry

The code in most of the fields vary from product to product. However, the first field always contains the code "P" which identifies the product as a sensor designed specifically for application in the plastics industry



Model No. P - - - -

Field 13

Attaching Device (Style)

After identifying the plastics industry sensor, the second most significant code is in Field 13. The style of a thermocouple is commonly defined by the way it attaches to the workpiece. The attaching device, also called process mounting, is specified in field 13 of the part number



Model No. P - - - -

All the various styles for the plastics industries thermocouples are:

<u>Code</u>	<u>Description</u>	<u>See Page</u>
0	Tube style with no mounting fitting	2-20, 2-24, 2-26, 2-28
1	Melt bolt style	2-36
2	Tube style with brass compression fitting	2-20, 2-24, 2-28
3	Tube style with stainless steel compression fitting	2-24, 2-26, 2-28
4	Tube style with bayonet lock	2-18, 2-20, 2-22, 2-24, 2-26
5	Nozzle melt style	2-32, 2-35
6	Armor style Varidepth®	2-10, 2-13
7	Ring or lug mount	2-30
8	Non-immersion nozzle melt style thermocouple	2-28, 2-34
B	Spring style Varidepth, standard lock cap, 12" spring	2-14, 2-16
D	Spring style Varidepth, 12 mm lock cap, 12" spring	2-14, 2-16
F	Spring style Varidepth, 15 mm lock cap, 12" spring	2-14, 2-16

After identifying the application and style of the thermocouple, you can now define the remaining specifications by the codes in other fields. They are:

Model Number Breakdown

Analyzing a Model Number (continued)

Fields 2 and 3	Element Two wires of dissimilar alloys joined at the tip. When the ends are exposed to a temperature gradient, and electromotive force (EMF) is generated. The EMF is very small, amounting to microvolts per degree.
Field 4	Element Configuration This field indicates either single or dual element in a straight, 45° angle, or 90° angle tube.
Field 5	Probe Diameter This code indicates either a 1/8" diameter or a 3/16" diameter.
Field 6	Junction Style and Protection This field indicates closed or open end, ground or ungrounded junction, and with or without flexible armor.
Field 7	Cold End Termination Specifies stripped ends, lugs, plug and/or jack.
Fields 8 and 9	Rigid Length or Melt Bolt Length This field specifies the rigid length of the probe (dimension "X") of those sensors with an adjustable attaching device; or the length of a melt bolt style sensor.
Fields 10, 11 and 12	Flexible Length This is the flexible length (dimension "Y") of the thermocouple. It is the entire length of the spring style Varidepth sensor, or the flexible portion behind the rigid portion of other assemblies. Flexible length may be fiberglass insulated, or clad with stainless steel overbraid or flexible armor.
Fields 14 and 15	Immersion Depth This code defines how the sensor interacts with the measured media. It defines the immersion depth (dimension "Z") of a typical sensor or the tip length (dimension "T") of a melt bolt sensor. Or, it defines the size of the ring or lug on the ring/lug style sensor.

Technical Data

Ordering Information

Illustrations on the following pages list wire most commonly used in specific thermocouples (Fields 2, 3 of the part number); however, any wire from the following table can be used. Standard and special limits (tolerances) are defined in Table 1 of the "Overview" section of this book, under "Certification."

When selecting thermocouple wire, be sure to check Table 2 and verify its compatibility with the probe o.d., junction style, and lead protection.

Table 1. Thermocouple Wire

Fields 2, 3. Thermocouple Type						
Code	Gauge	Limits	Construction	Insulation	Part Number	
Type J – Rated at 900°F except Teflon insulated (code 25) rated at 400°F*						
01	20	Std	Solid	Fiberglass	WJ20-11305	
07				Fiberglass w/SS	WJ20-12305	
11			Strand	Fiberglass w/SS	WJ20-32302	
12				Fiberglass	WJ20-31302	
25			Spl	Solid	Teflon	WJ20-11507
60				Fiberglass	WJ20-21305	
02	24	Std	Solid	Fiberglass	WJ24-11305	
13				Fiberglass w/SS	WJ24-12305	
15			Strand	Fiberglass w/SS	WJ24-32305	
26				Fiberglass	WJ24-31305	
61			Spl	Solid	Fiberglass	WJ24-21305
09				18	Std	Strand
Type K – Rated at 900°F*						
05	20	Std	Solid	Fiberglass	WK20-11305	
08				Fiberglass w/SS	WK20-12305	
20			Spl	Strand	Fiberglass	WK20-31302
62				Solid	Fiberglass	WK20-21304
19	24	Std	Fiberglass		WK24-11304	
24	Std	Fiberglass w/SS	WK24-12305			
63	Spl	Fiberglass	WK24-21304			
Type E – Rated at 900°F*						
17	20	Std	Solid	Fiberglass	WE20-11304	
18	24				WE24-11304	
Type T – 20 gauge rated at 500°F; 24 gauge rated at 400°F*						
06	20	Std	Solid	Fiberglass	WT20-11304	
64		Spl			WT20-21304	
14	24	Std			WT24-11304	
w/SS = with stainless steel overbraid.						
*Rating is maximum continuous temperature of wire only; maximum operating temperature of thermocouple assembly may be lower.						

Technical Data

Ordering Information (continued)

Component Compatibility

The number of elements in a thermocouple is constrained by wire size, probe diameter, and lead protection. The table below shows the compatibility of these components

Table 2. Compatibility

Fields 5, 6. Junction Style, Probe O.D., Lead Protection								
Code	21	23	30	31	32	33	34	35
Probe O.D.	1/8"		3/16"					
Tip	Grounded		Grounded				Ungrounded	
	Closed		Open	Closed	Open	Closed	Closed	
Flex Tube	No	Yes	No		Yes		No	Yes
Fields 2, 3. T/C Type								
01	None		Single or Dual				Single	
02	Single		Single or Dual				Single or Dual	
05	None		Single or Dual				Single	
06	None		Single or Dual				Single	
07	None		Single		None	Single	Single	
08	None		Single		None	Single	Single	
09	None		Single				None	
11	None		Single		None	Single	None	
12	None		Single				None	
13	Single		Single or Dual				Single*	
14	Single		Single or Dual				Single or Dual	
15	Single		Single or Dual				Single*	
17	None		Single or Dual				Single	
18	Single		Single or Dual				Single or Dual	
19	Single		Single or Dual				Single or Dual	
20	None		Single				None	
24	Single		Single or Dual				Single or Dual	
25	Single		Single or Dual				Single or Dual	
26	Single		Single or Dual				Single or Dual	
60	None		Single or Dual				Single	
61	Single		Single or Dual				Dual	
62	None		Single or Dual				Single	
63	Single		Single or Dual				Dual	
64	None		Single or Dual				Single	

* Dual only for code 34 spring style

Varidepth T/C, Armor

Varidepth® Adjustable Depth Immersion Thermocouple in Armor Clad Flexible Tube

Introduction

The Varidepth thermocouple adjusts to many depths eliminating the need to stock a variety of fixed immersion sensors. Compression of the flexible tube provides locking force that keeps the probe tip tight against the well bottom. Varidepth thermocouples are available in Types J, K, T and E. Grounded Type K thermocouples have a welded tip; Types J, T and E thermocouples have silver soldered tipped probes for faster response.

Features

- Locking Cap Adjusts Easily to Any Position On Flexible Tube
- Compressed Tube Holds Probe Tip Firmly Against Well Bottom
- Thermocouple at Tip of Probe for Maximum Heat Transfer
- Types J, K, E Withstand up to 750°F Over Probe and Tube
- Type T Withstands up to 500°F

Ordering Information

Model No. P - **00** - - **6 - 0 0**
 Field No. 1 2 3 4 5 6 7 8 9 10 11 12 13 14 15

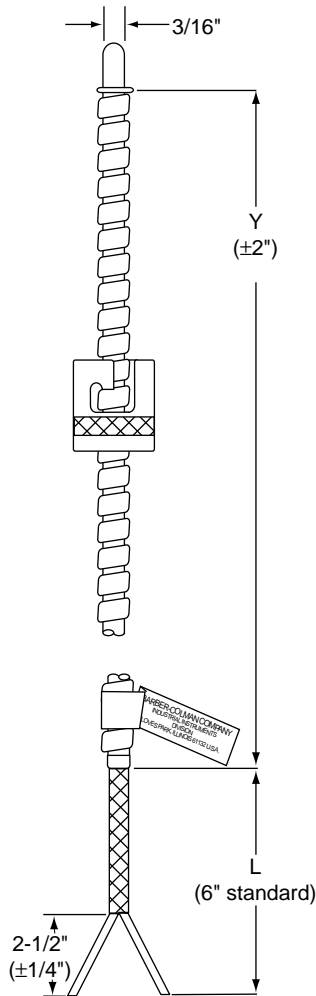

Field 1. BASE MODEL

P - Plastics industry

Fields 2, 3. THERMOCOUPLE TYPE

Fiberglass insulation unless otherwise stated.

☞ Determine length (Y + L) by completing Fields 10, 11, 12, and Field 7.

Type Description

01 -	J	20 gauge, solid
02 -	J	24 gauge, solid
12 -	J	20 gauge, strand
60 -	J	20 gauge, solid, special limits
05 -	K	20 gauge, solid
62 -	K	20 gauge, solid, special limits

Several other wire codes are available. See Table 1 on page 2-8 for a complete listing. Compatibility of wire and junction styles is listed in Table 2 on page 2-9.

Field 4. NUMBER OF ELEMENTS

Complete Fields 5, 6; then check compatibility Table 2 on page 2-9.

- 1 - Single element
- 4 - Dual element. (24 gauge element only). Return to Fields 2, 3.

Fields 5, 6. JUNCTION STYLE, LEAD PROTECTION

☞ Determine length by completing Fields 10, 11, 12

- 33 - Closed end, grounded, flexible tube
- 35 - Closed end, ungrounded, flexible tube (24 gauge only, single element only)

Varidepth T/C, Armor

Ordering Information (continued)

Field 7. COLD END TERMINATION

- 0 - 2-1/2" split leads, ends stripped
- 1 - 2-1/2" split leads, spade lugs
- 2 - 2-1/2" split leads, spade lugs, 1/2" NPS box connector with lock nut
- 3 - Solid pin quick disconnect plug(s)
- 4 - Solid pin quick disconnect plug(s) with mating jack(s)
- 7 - Quick disconnect jack(s)
- C - Hollow pin quick disconnect plug(s), Type J only
- D - Hollow pin quick disconnect plug(s) with mating jack(s), Type J only

Extended Lead (DIMENSION "L")

 Complete this Field to determine length for Fields 2, 3

- F - 12", split ends stripped
 - G - 24", split ends stripped
 - H - 48", split ends stripped
 - J - 96", split ends stripped
 - K - 144", split ends stripped
- For other lengths, consult factory

Fields 8, 9. RESERVED

Fields 10, 11, 12. FLEXIBLE LENGTH (DIMENSION "Y")

 Complete these Fields to determine length for Fields 2, 3; and 5, 6

YYY - Enter "Y" length in whole inches; minimum 018"

Fields 13, 14, 15. RESERVED

The most often ordered assemblies are:

- P011-33000-YYY-6-00 with stripped leads
- P011-33100-YYY-6-00 with spade lugs
- P011-33300-YYY-6-00 with quick disconnect plug

Refer to Price Guide

Varidepth RTD, Armor

Varidepth® Adjustable Depth Immersion RTD in Armor Clad Flexible Tube

Introduction

The Varidepth resistance temperature detector adjusts to many depths eliminating the need to stock a variety of fixed immersion sensors. Compression of the flexible tube provides locking force that keeps the probe tip tight against the bottom of the adapter well.

Features

- **Locking Cap Adjusts Easily to Any Position On Flexible Tube**
- **Compressed Tube Holds Probe Tip Firmly Against Well Bottom**
- **RTD at Tip of Probe for Maximum Heat Transfer**

Varidepth Installation Procedure

1. Using a number 9 drill, bore a hole to the immersion depth.
2. Using a 9/32" drill, bore a hole to within 7/8" of the adapter well bottom. Clean chips from hole.
3. Tap the open end of the adapter well for 1/8" NPT or 3/8-24. Clean chips from hole.
4. Install adapter. Minimum distance recommended from bottom of well to top of adapter is four inches.
5. Insert probe into adapter.
6. Hold probe firmly against bottom of well. Rotate locking cap on flexible tube until it is about one turn from adapter. Press and twist the locking cap to lock it against the adapter. Be certain the probe is firmly seated in the well.
7. The six inch leads must be free to move to allow the flexible tubing to compress at the probe end. A one inch diameter loop in the leads is suggested.
8. Wire the RTD to indicator or controller instrument per instructions of the instrument manufacturer.

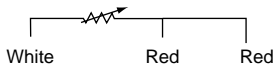
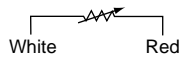
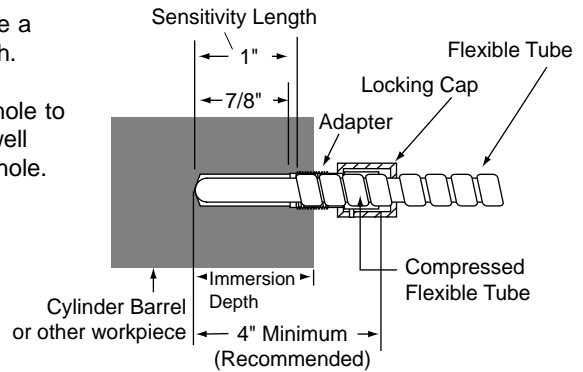

Varidepth RTD, Armor

Ordering Information

Model No. P - **3 3** **0 0** - - **6** -

Field No. 1 2 3 4 5 6 7 8 9 10 11 12 13 14 15

Fields 1, 2. BASE MODEL

P5 - 0.00391 $\Omega/\Omega/^\circ\text{C}$ Resistance Temperature Detector

P7 - 0.00385 $\Omega/\Omega/^\circ\text{C}$ Resistance Temperature Detector

Field 3. ELEMENT

Determine length (Y + L) by completing Fields 10, 11, 12, and Fields 14, 15.

	<u>Accuracy (at 300°F)</u>	<u>Temp Rating</u>	<u>Wires</u>
1 -	0.25%	500°F	3
2 -	0.10%	932°F	3
3 -	0.25%	932°F	3
4 -	0.10%	500°F	2
5 -	0.25%	932°F	2
6 -	0.10%	500°F	3

Field 4. NUMBER OF ELEMENTS, CONFIGURATION

- 1 - Single element, straight
- 4 - Dual element, straight (P74 or P75 only)

Fields 5, 6. RESERVED

Field 7. COLD END TERMINATION

- 0 - 2-1/2" split leads, ends stripped
- 1 - 2-1/2" split leads, spade lugs
- 2 - 2-1/2" split leads, spade lugs, 1/2" NPS box connector with lock nut
- 3 - Solid pin quick disconnect plug
- 4 - Solid pin quick disconnect plug with mating jack

Fields 8, 9. RESERVED

Field 10, 11, 12. FLEXIBLE LENGTH (DIMENSION "Y")*

Complete these Fields to determine length for Field 3
 YYY - Actual length in whole inches (minimum 018)

Field 13. RESERVED

Fields 14, 15. LEAD LENGTH (DIMENSION "L")*

Complete these Fields to determine length for Field 3
 00 - 6"
 LL - Actual length in feet
 99 - Longer than 98 feet

*Total assembly length over 4 feet introduces an offset in sensed temperature of approximately 1-1/4°F per 10 feet over 4 feet.

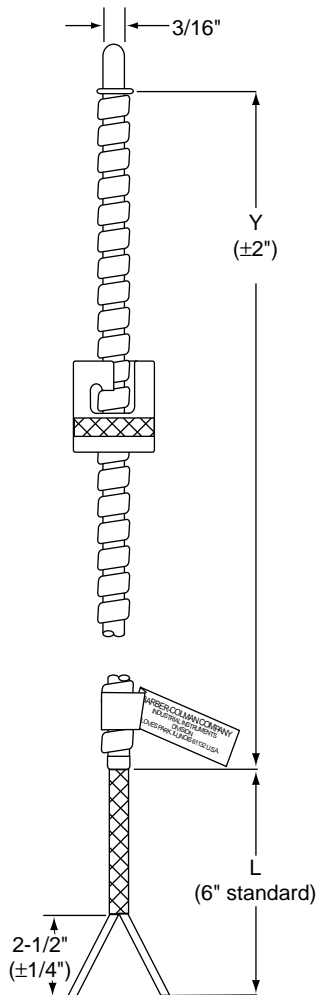

Varidepth T/C, Spring Style

Varidepth® Adjustable Depth Immersion Thermocouple Spring Style

Introduction

The Varidepth thermocouple adjusts to many depths eliminating the need to stock a variety of fixed immersion length sensors. The locking cap rotates on the flexible spring achieving locking force that keeps the probe tip tight against the bottom of the adapter well. Varidepth thermocouples are available in Types J, K, T and E. Grounded Type K thermocouples have a welded tip; grounded Types J, T and E thermocouples have silver soldered tipped probes for faster response.

Features

- Locking Cap Adjusts Easily to Any Position On Flexible Spring
- Compressed Tube Holds Rigid Probe Firmly Against Well Bottom
- Thermocouple at Tip of Probe for Maximum Heat Transfer
- Maximum 750°F Over Probe

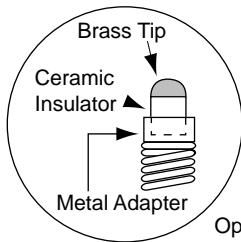

Optional Junction
(Code 61)

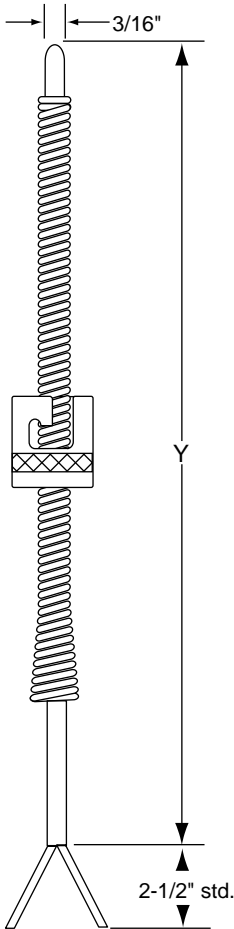

Model No. P - **00** - - **00**
 Field No. 1 2 3 4 5 6 7 8 9 10 11 12 13 14 15

Field 1. BASE MODEL

P - Plastics industry

Fields 2, 3. THERMOCOUPLE TYPE

Fiberglass insulation unless otherwise stated.

☞ Determine length by completing Fields 10, 11, 12

Type	Description
11 - J	20 gauge, strand, stainless steel overbraid
07 - J	20 gauge, solid, stainless steel overbraid
13 - J	24 gauge, solid, stainless steel overbraid
15 - J	24 gauge, strand, stainless steel overbraid
08 - K	20 gauge, stainless steel overbraid
24 - K	24 gauge, solid, stainless steel overbraid

Several other wire codes are available. See Table 1 on page 2-8 for a complete listing. Compatibility of wire and junction styles is listed in Table 2 on page 2-9.

Field 4. NUMBER OF ELEMENTS

Complete Fields 5, 6; then check compatibility Table 2 on page 2-9.

- 1 - Single element
- 4 - Dual element (24 gauge only)

Fields 5, 6. JUNCTION STYLE

- 31 - Closed end, grounded
- 34 - Closed end, ungrounded (24 gauge, single element only)
- 61 - Brass tip, grounded (single element only)

Varidepth T/C, Spring Style

Ordering Information (continued)

Field 7. COLD END TERMINATION

- 0 - 2-1/2" split leads, ends stripped
- 1 - 2-1/2" split leads, spade lugs
- 2 - 2-1/2" split leads, spade lugs, 1/2" NPS box connector with lock nut
- 3 - Solid pin quick disconnect plug(s)
- 4 - Solid pin quick disconnect plug(s) with mating jack(s)
- 7 - Quick disconnect jack(s)
- C - Hollow pin quick disconnect plug(s), Type J only
- D - Hollow pin quick disconnect plug(s) with mating jack(s), Type J only

Fields 8, 9. RESERVED

Fields 10, 11, 12. FLEXIBLE LENGTH (DIMENSION "Y")

 Complete these Fields to determine length for Fields 2, 3
YYY - Enter "Y" length in whole inches; minimum 018"

Field 13. SPRING AND LOCKCAP

- B - 12" spring, standard lockcap
- D - 12" spring, 12 mm lockcap
- F - 12" spring, 15 mm lockcap

Fields 14, 15. RESERVED

The most often ordered assemblies are:

- P111-31000-YYY-B-00 with stripped leads
- P111-31100-YYY-B-00 with spade lugs
- P111-31300-YYY-B-00 with quick disconnect plug

Refer to Price Guide

Varidepth RTD, Spring Style

Varidepth® Adjustable Depth Immersion RTD Spring Style

Ordering Information

Model No. P **1 - 3 1** **0 0 -** **-** **- 0 0**
 Field No. 1 2 3 4 5 6 7 8 9 10 11 12 13 14 15

Fields 1, 2. BASE MODEL

P5 - 0.00391 $\Omega/\Omega/^\circ\text{C}$ Resistance Temperature Detector
 P7 - 0.00385 $\Omega/\Omega/^\circ\text{C}$ Resistance Temperature Detector

Field 3. ELEMENT

Determine length by completing Fields 10, 11, 12

	Accuracy (at 300°F)	Temp Rating	Wires
1 -	0.25%	500°F	3
2 -	0.10%	932°F	3
3 -	0.25%	932°F	3
4 -	0.10%	500°F	2
5 -	0.25%	932°F	2
6 -	0.10%	500°F	3

Fields 4, 5, 6 RESERVED

Field 7. COLD END TERMINATION

- 0 - 2-1/2" split leads, ends stripped
- 1 - 2-1/2" split leads, spade lugs
- 2 - 2-1/2" split leads, spade lugs, 1/2" NPS box connector with lock nut
- 3 - Solid pin quick disconnect plug
- 4 - Solid pin quick disconnect plug with mating jack

Fields 8, 9. RESERVED

Fields 10, 11, 12. FLEXIBLE LENGTH (DIMENSION "Y")*

Complete these Fields to determine length for Field 3

YYY - Actual length in whole inches (minimum 018")

*Total assembly length over 4 feet introduces an offset in sensed temperature of approximately 1-1/4°F per 10 feet over 4 feet.

Field 13. SPRING AND LOCKCAP

- B - 12" spring, standard lockcap
- D - 12" spring, 12 mm lockcap
- F - 12" spring, 15 mm lockcap

Fields 14, 15. RESERVED

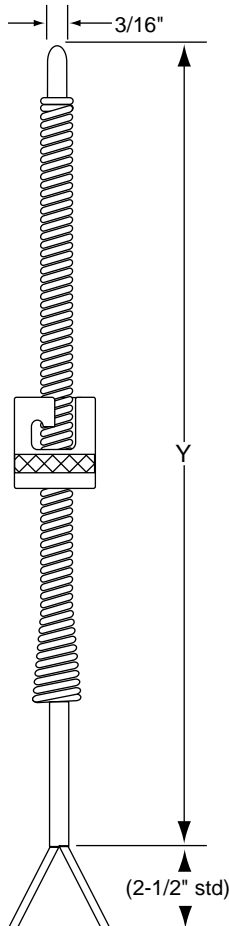

For a Complete Selection of Accessories and Component Parts, See Our Listing Under "Accessories" Beginning on Page 2-40

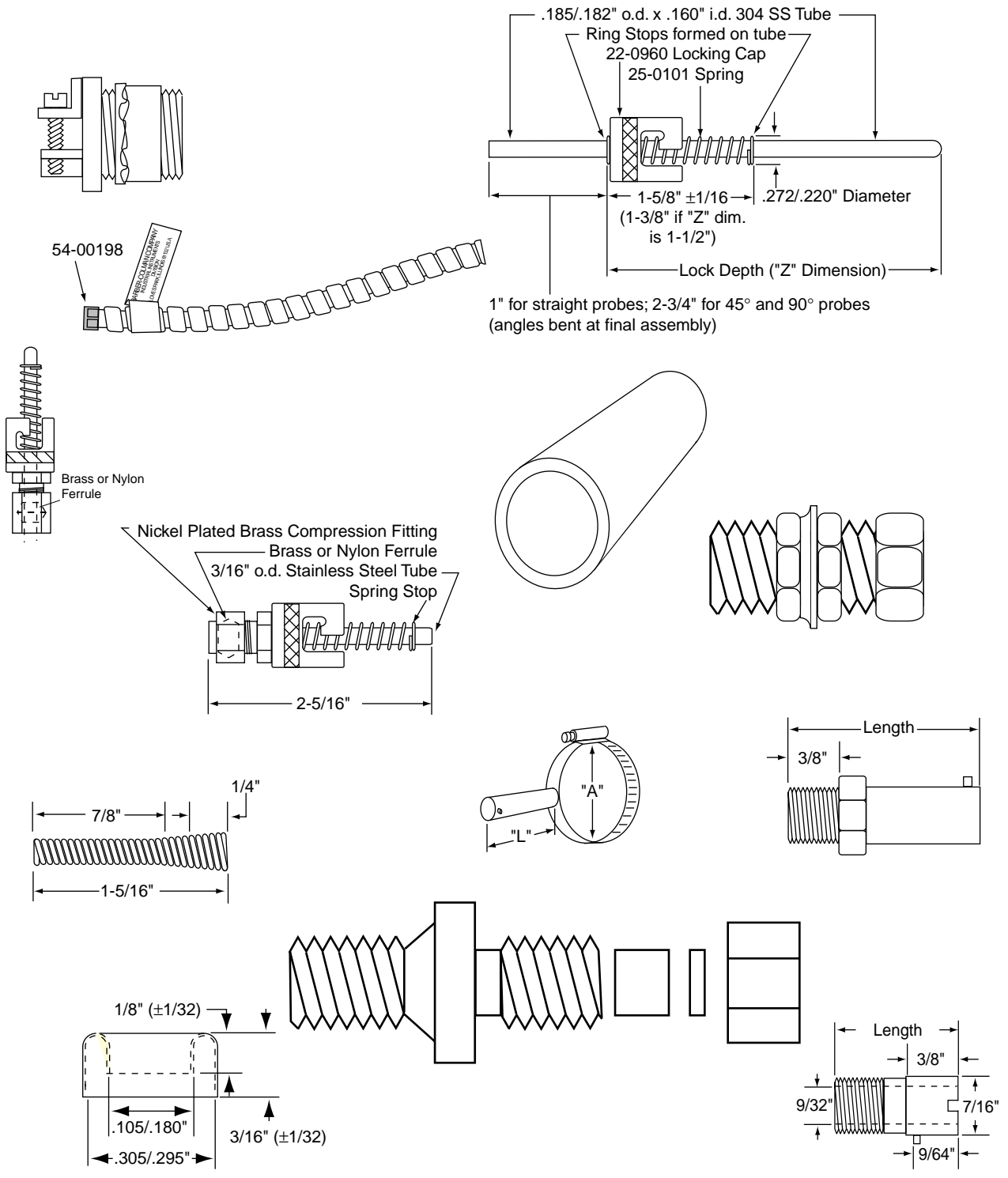

Fixed T/C, Bayonet

Fixed Depth Immersion Thermocouple with Bayonet Lock

Introduction

Bayonet thermocouples have a compressible spring and locking cap for quick insertion and detachment. They are available with no protection tube (insulation only), armor clad flexible tube, or stainless steel overbraid. All are light weight for easy connection to an instrument or a distant junction box. Closed end tubes are silver soldered for Types J, T and E; and welded for Type K. Bayonet thermocouples are generally rated for service to 900°F under dry conditions; temperature rating does not apply to cold end terminations.

Features

- Locking Cap/Spring for Quick and Easy Attachment/Detachment
- Compressed Spring Holds Rigid Probe Firmly Against Well Bottom
- Thermocouple at Tip of Probe for Maximum Heat Transfer
- Maximum 900°F Over Probe and Tube

Model No. P - 0 0 - - 4 -

Field No. 1 2 3 4 5 6 7 8 9 10 11 12 13 14 15

Field 1. BASE MODEL

P - Plastics industry

Fields 2, 3. THERMOCOUPLE TYPE

Fiberglass insulation unless otherwise stated.

☞ Determine length (Y + L) by completing Fields 10, 11, 12 and Field 7.

Type Description

- | | | |
|------|---|---|
| 01 - | J | 20 gauge, solid |
| 07 - | J | 20 gauge, stainless steel overbraid |
| 11 - | J | 20 gauge, strand, stainless steel overbraid |
| 05 - | K | 20 gauge, solid |

Several other wire codes are available. See Table 1 on page 2-8 for a complete listing. Compatibility of wire and junction styles is listed in Table 2 on page 2-9.

Field 4. NUMBER OF ELEMENTS, PROBE CONFIGURATION

Complete Fields 5, 6; then check compatibility Table 2 on page 2-9.

- 1 - Single element, straight
- 2 - Single element, 90°
- 3 - Single element, 45°
- 4 - Dual element, straight (24 gauge only)
- 5 - Dual element, 90° (24 gauge only)
- 6 - Dual element, 45° (24 gauge only)

Fields 5, 6. JUNCTION STYLE, LEAD PROTECTION

☞ Determine length by completing Fields 10, 11, 12.

- | | | |
|------|------------------------|------------------|
| 30 - | Open end, grounded, | no flexible tube |
| 31 - | Closed end, grounded | no flexible tube |
| 32 - | Open end, grounded | flexible tube |
| 33 - | Closed end, grounded | flexible tube |
| 34 - | Closed end, ungrounded | no flexible tube |
| 35 - | Closed end, ungrounded | flexible tube |

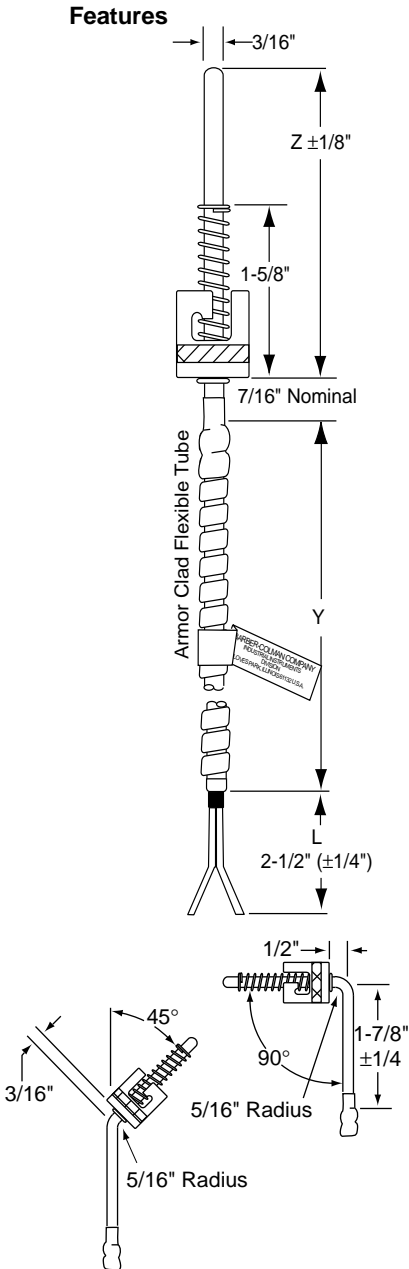

Fixed T/C, Bayonet

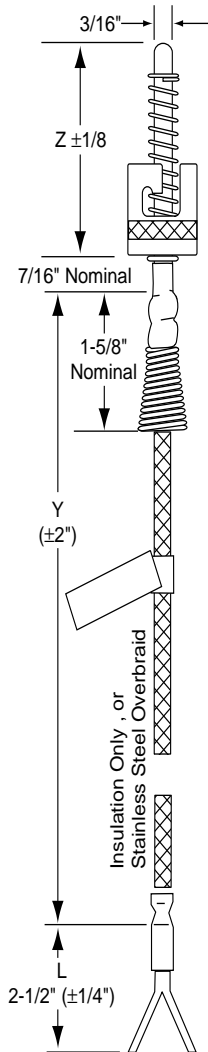

Field 7. COLD END TERMINATION

- 0 - 2-1/2" split leads, ends stripped
- 1 - 2-1/2" split leads, spade lugs
- 2 - 2-1/2" split leads, spade lugs, 1/2" NPS box connector with lock nut
- 3 - Solid pin quick disconnect plug(s)
- 4 - Solid pin quick disconnect plug(s) with mating jack(s)
- 7 - Quick disconnect jack(s)
- C - Hollow pin quick disconnect plug(s), Type J only
- D - Hollow pin quick disconnect plug(s) with mating jack(s), Type J only

Extended Lead (DIMENSION "L")

☞ Complete this Field to determine length for Fields 2, 3.

- F - 12", split ends stripped
 - G - 24", split ends stripped
 - H - 48", split ends stripped
 - J - 96", split ends stripped
 - K - 144", split ends stripped
- For other lengths, consult factory

Fields 8, 9. RESERVED

Fields 10, 11, 12. FLEXIBLE LENGTH (DIMENSION "Y")

☞ Complete these Fields to determine length for Fields 2, 3: and 5, 6.

YYY - Enter "Y" length in whole inches; minimum 018"

Field 13. RESERVED

Fields 14, 15. LOCK DEPTH (DIMENSION "Z")

Add adapter length to immersion (hole) depth; then add 3/16" if adapter has 1/8 NPT, or 1/16" if adapter has 3/8-24 thread. Round "Z" dimension upward to nearest 1/8".

ZZ - See table below.

01 1-1/2"	04 3"	31 4-3/8"	10 6"
14 1-5/8"	23 3-1/8"	07 4-1/2"	41 6-1/8"
15 1-3/4"	24 3-1/4"	32 4-5/8"	42 6-1/4"
16 1-7/8"	05 3-1/2"	33 4-3/4"	43 6-3/8"
02 2"	25 3-3/8"	34 4-7/8"	11 6-1/2"
17 2-1/8"	05 3-1/2"	08 5"	44 6-5/8"
18 2-1/4"	26 3-5/8"	35 5-1/8"	45 6-3/4"
19 2-3/8"	27 3-3/4"	36 5-1/4"	46 6-7/8"
03 2-1/2"	28 3-7/8"	37 5-3/8"	12 7"
20 2-5/8"	06 4"	09 5-1/2"	47 7-1/8"
21 2-3/4"	29 4-1/8"	38 5-5/8"	48 7-1/4"
22 2-7/8"	30 4-1/4"	39 5-3/4"	49 7-3/8"
99 - Not listed; specify on order		40 5-7/8"	13 7-1/2"

The most often ordered assemblies are:

With Flexible Tube

- P011-33000-YYY-4-ZZ with stripped leads
- P011-33100-YYY-4-ZZ with spade lugs
- P011-33300-YYY-4-ZZ with quick disconnect plug

With Stainless Steel Overbraid

- P111-31000-YYY-4-ZZ with stripped leads
- P111-31100-YYY-4-ZZ with spade lugs
- P111-31300-YYY-4-ZZ with quick disconnect plug

Refer to Price Guide

Thermistors

Fixed Depth Immersion Thermistor with Bayonet Lock or

Adjustable Depth Immersion Thermistor with Compression Fitting

Introduction

These thermistor probes are available with the attaching lock depth either fixed at the factory ("Z" dimension), or with an adjustable attaching device that you set when you install the probe. Fixed device is bayonet lock; adjustable device is secured with a a compression fitting.

Ordering Information

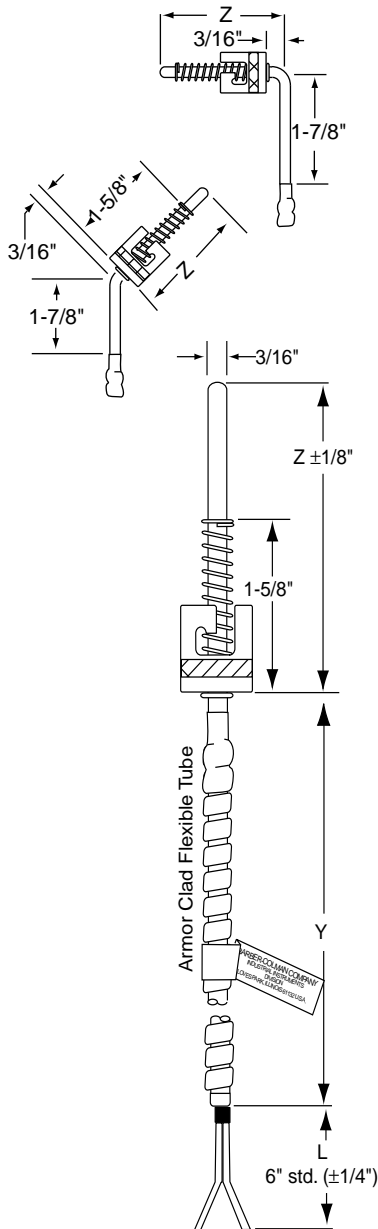

Model No. P - 3 3 - - -

Field No. 1 2 3 4 5 6 7 8 9 10 11 12 13 14 15

Field 1. BASE MODEL

P - Plastics industry

Fields 2, 3. ELEMENT TYPE

- 21 - 100 to 300°F; 10 kΩ at 25°C
- 22 - 200 to 500°F; 100 kΩ at 25°C
- 23 - 350 to 600°F; 1 MΩ at 25°C
- 41 - 100 to 300°F; 10 kΩ at 25°C with Type J thermocouple
- 42 - 200 to 500°F; 100 kΩ at 25°C with Type J thermocouple
- 43 - 350 to 600°F; 1 MΩ at 25°C with Type J thermocouple

Field 4. PROBE CONFIGURATION

- 1 - Straight
- 2 - 90°
- 3 - 45°

Fields 5, 6. RESERVED

Field 7. COLD END TERMINATION (DIMENSION "L")

- 0 - 2-1/2" split leads, ends stripped
- 1 - 2-1/2" split leads, spade lugs
- 2 - 2-1/2" split leads, spade lugs, 1/2" NPS box connector with lock nut
- 3 - Solid pin quick disconnect plug(s)
- 4 - Solid pin quick disconnect plug(s) with mating jack(s)
- 7 - Quick disconnect jack(s)

Extended Lead (DIMENSION "L")

- F - 12", split ends stripped
 - G - 24", split ends stripped
 - H - 48", split ends stripped
 - J - 96", split ends stripped
 - K - 144", split ends stripped
- For other lengths, consult factory

Thermistors

Ordering Information (continued)

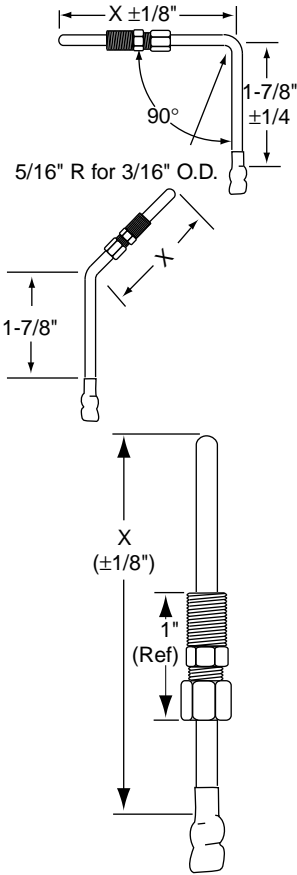

Compression Fitting

Fields 8, 9. RIGID LENGTH (DIMENSION "X")(COMPRESSION FITTING ONLY)

- 00 - Not applicable. (Bayonet lock. See Fields 14, 15)
- XX - Enter "X" length in whole inches

Fields 10, 11, 12. FLEXIBLE LENGTH (DIMENSION "Y")

- 000 - None
- YYY - Enter "Y" length in whole inches; minimum 018"

Field 13. ATTACHING DEVICE

- 0 - None
- 2 - Adjustable 1/8" NPT nickel plated brass fitting
- 4 - Bayonet lock

Fields 14, 15. LOCK DEPTH (DIMENSION "Z") (BAYONET LOCK ONLY)

- 00 - Not applicable (Compression fitting. See Fields 8, 9)
- ZZ - See table below.

01 ... 1-1/2"	02 2"	03 2-1/2"	04 3"
05 ... 3-1/2"	06 4"	07 4-1/2"	08 5"
09 ... 5-1/2"	10 6"	11 6-1/2"	12 7"
13 ... 7-1/2"			

99 - Not listed above. Specify "Z" dimension on order.

Fixed RTD, Bayonet

Fixed Depth Immersion RTD with Bayonet Lock

Introduction

Bayonet resistance temperature detectors have a compressible spring and locking cap for quick insertion and detachment. They are available with no protection tube (insulation only), armor clad flexible tube, or stainless steel overbraid. All are light weight for easy connection to an instrument or a distant junction box.

Ordering Information

Model No. P - **00** - - **4** -

Field No. 1 2 3 4 5 6 7 8 9 10 11 12 13 14 15

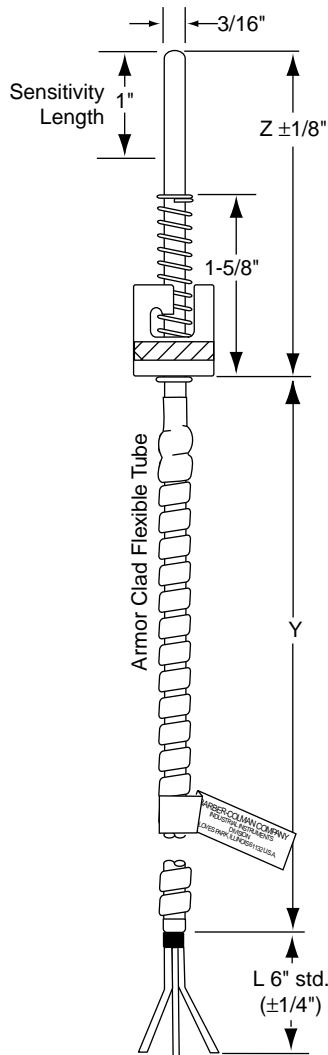

Fields 1, 2. BASE MODEL

- P5 - 0.00391 $\Omega/\Omega/^\circ\text{C}$ Resistance Temperature Detector
- P7 - 0.00385 $\Omega/\Omega/^\circ\text{C}$ Resistance Temperature Detector
- P8 - 0.00385 $\Omega/\Omega/^\circ\text{C}$ RTD and Type J Thermocouple

Field 3. ELEMENT

	Accuracy (at 300°F)	Temp Rating	Wires
1 -	0.25%	500°F	3
2 -	0.10%	932°F	3
3 -	0.25%	932°F	3
4 -	0.10%	500°F	2
5 -	0.25%	932°F	2
6 -	0.10%	500°F	3

Field 4. NUMBER OF ELEMENTS; CONFIGURATION

- 1 - Single element, straight
- 2 - Single element, 90°
- 3 - Single element, 45°
- 4 - Dual element*, straight
- 5 - Dual element*, 90°
- 6 - Dual element*, 45°

* Dual element is only available when field 3 code is 4 or 5.

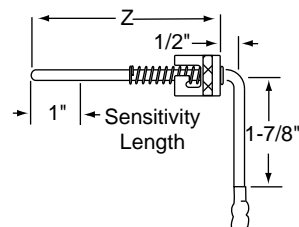
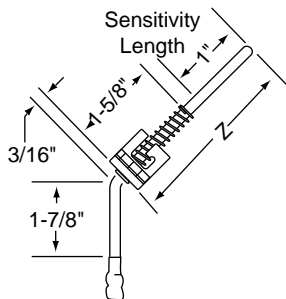

Fixed RTD, Bayonet

Ordering Information (continued)

Fields 5, 6. PROTECTION

 Determine length by completing Fields 10, 11, and 12.

Model P5 or Model P7

- 31 - No lead, or lead with stainless steel overbraid
- 33 - Leadwire with flexible armor

Model P8

- 31 - No lead, or lead with stainless steel overbraid
- 33 - Leadwire with flexible armor

Field 7. COLD END TERMINATION

- 0 - 2-1/2" split leads, ends stripped
- 1 - 2-1/2" split leads, spade lugs
- 2 - 2-1/2" split leads, spade lugs, 1/2" NPS box connector with lock nut
- 3 - Solid pin quick disconnect plug
- 4 - Solid pin quick disconnect plug with mating jack

Extended Lead (DIMENSION "L")

- F - 12", split ends stripped
 - G - 24", split ends stripped
 - H - 48", split ends stripped
 - J - 96", split ends stripped
 - K - 144", split ends stripped
- For other lengths, consult factory.

Fields 8, 9. RESERVED

Fields 10, 11, 12. FLEXIBLE LENGTH (DIMENSION "Y")*

 Complete these Fields to determine length for Fields 5, 6
YYY - Actual length in whole inches (minimum 018")

Field 13. RESERVED

Fields 14, 15. LOCK DEPTH (DIMENSION "Z")*

03 2-1/2"	06 4"	38 5-5/8"	12 7"
20 2-5/8"	29 4-1/8"	39 5-3/4"	47 7-1/8"
21 2-3/4"	30 4-1/4"	40 5-7/8"	48 7-1/4"
22 2-7/8"	31 4-3/8"	10 6"	49 7-3/8"
04 3"	07 4-1/2"	41 6-1/8"	13 7-1/2"
23 3-1/8"	32 4-5/8"	42 6-1/4"	
24 3-1/4"	33 4-3/4"	43 6-3/8"	
05 3-1/2"	34 4-7/8"	11 6-1/2"	
25 3-3/8"	08 5"	44 6-5/8"	
05 3-1/2"	35 5-1/8"	45 6-3/4"	
26 3-5/8"	36 5-1/4"	46 6-7/8"	
27 3-3/4"	37 5-3/8"		
28 3-7/8"	09 5-1/2"		

99 - Not listed; specify on order

*Total assembly length over 4 feet introduces an offset in sensed temperature of approximately 1-1/4°F per 10 feet over 4 feet.

Adjustable T/C, Bayonet or Compression

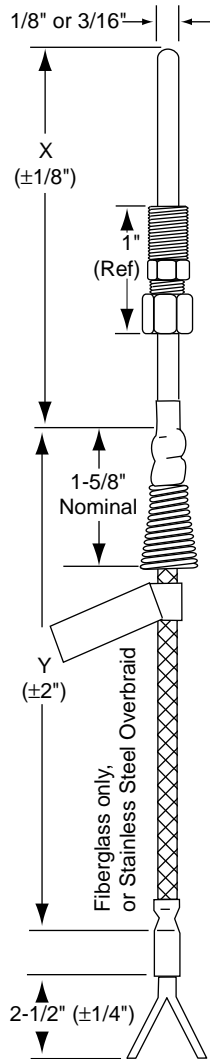

Fields 5, 6. JUNCTION STYLE, PROBE O.D., LEAD PROTECTION

☞ Determine length by completing Fields 10, 11, 12.

21 - Closed end, grounded	1/8"	no flexible tube
23 - Closed end, grounded	1/8"	flexible tube
30 - Open end, grounded	3/16"	no flexible tube
31 - Closed end, grounded	3/16"	no flexible tube
32 - Open end, grounded	3/16"	flexible tube
33 - Closed end, grounded	3/16"	flexible tube
34 - Closed end, ungrounded	3/16"	no flexible tube (24 gauge, single element only)
35 - Closed end, ungrounded	3/16"	flexible tube (24 gauge, single element only)

Field 7. COLD END TERMINATION

- 0 - 2-1/2" split leads, ends stripped
- 1 - 2-1/2" split leads, spade lugs
- 2 - 2-1/2" split leads, spade lugs, 1/2" NPS box connector with lock nut
- 3 - Solid pin quick disconnect plug(s)
- 4 - Solid pin quick disconnect plug(s) with mating jack(s)
- 7 - Quick disconnect jack(s)
- C - Hollow pin quick disconnect plug(s), Type J only
- D - Hollow pin quick disconnect plug(s) with jack(s), Type J only

Extended Lead (DIMENSION "L")

☞ Complete this Field to determine length for Fields 2, 3.

- F - 12", split ends stripped
 - G - 24", split ends stripped
 - H - 48", split ends stripped
 - J - 96", split ends stripped
 - K - 144", split ends stripped
- For other lengths, consult factory.

Fields 8, 9. RIGID LENGTH (DIMENSION "X")

XX - Enter "X" length in whole inches

Fields 10, 11, 12. FLEXIBLE LENGTH (DIMENSION "Y")

☞ Complete these Fields to determine length for Fields 2, 3; and 5, 6.

YYY - Enter "Y" length in whole inches; minimum 018"

Field 13. ATTACHING DEVICE

- 0 - None
- 2 - 1/8" NPT compression fitting, nickel plated brass
- 3 - 1/8" NPT compression fitting, stainless steel
- 4 - Adjustable bayonet, 1/8" tube only ("X" must be at least 3")

Fields 14, 15. RESERVED

The most often ordered assemblies are:

With Flexible Tube

- P011-330XX-YYY-2-00 with stripped leads
- P011-331XX-YYY-2-00 with spade lugs
- P011-333XX-YYY-2-00 with quick disconnect plug

With Stainless Steel Overbraid

- P111-310XX-YYY-2-00 with stripped leads
- P111-311XX-YYY-2-00 with spade lugs
- P111-313XX-YYY-2-00 with quick disconnect plug

Refer to Price Guide

Rigid T/C, Fixed or Adjustable

Rigid Tube Thermocouples Fixed or Adjustable Depth Immersion

Introduction

Thermocouple wire is duplex insulated, temperature rated to 900°F except Type T which is limited to 700°F. These temperatures do not apply to cold end termination. Standard junction style is closed and grounded. Type K has a welded tip; others are silver soldered tipped probes for faster response.

Features

- Thermocouple at Tip of Probe for Maximum Heat Transfer
- Maximum 900°F Over Probe and Tube, except Type T is 700°F

Ordering Information

Model No. P - - 0 0 0 - -
Field No. 1 2 3 4 5 6 7 8 9 10 11 12 13 14 15

Field 1. BASE MODEL

P - Plastics industry

Fields 2, 3. THERMOCOUPLE TYPE

☛ Determine length by completing Fields 8, 9.

Type	Description
01 - J	20 gauge, solid
02 - J	24 gauge, solid
12 - J	20 gauge, strand
25 - J	20 gauge, solid, Teflon insulated, 400°F max.
60 - J	20 gauge, solid, special limits
05 - K	20 gauge, solid
62 - K	20 gauge, solid, special limits

Several other wire codes are available. See Table 1 on page 2-8 for a complete listing. Compatibility of wire and junction styles is listed in Table 2 on page 2-9.

Field 4. NUMBER OF ELEMENTS, PROBE CONFIGURATION

Complete Fields 5, 6

- 1 - Single element, straight
- 2 - Single element, 90°
- 3 - Single element, 45°
- 4 - Dual element, straight. Return to Fields 2, 3.
- 5 - Dual element, 90°. Return to Field 2.
- 6 - Dual element, 45°. Return to Field 3.

Note: Dual element applicable to 24 gauge only.
Note: Dual element has common junction.

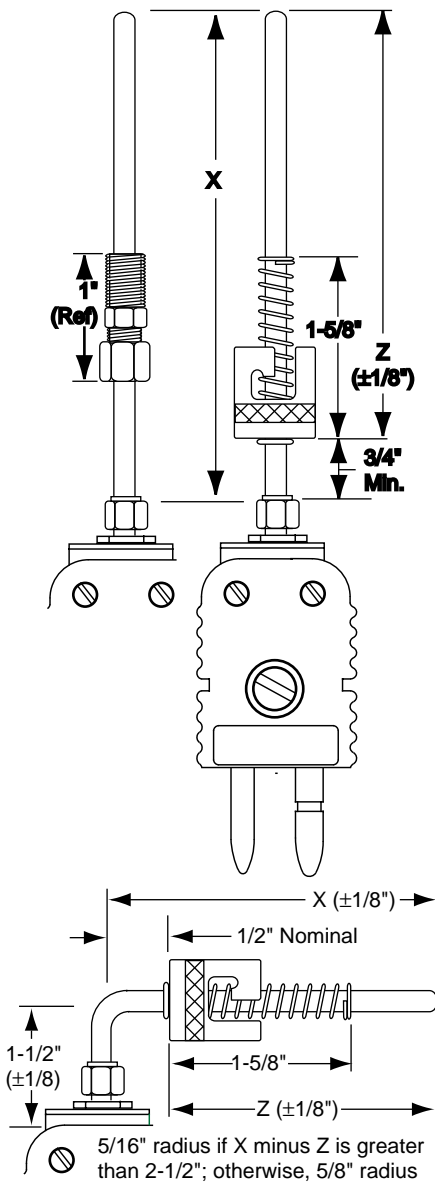

Rigid T/C, Fixed or Adjustable

Fields 5, 6. JUNCTION STYLE, PROBE O.D., LEAD PROTECTION

Check compatibility Table 2 at beginning of this section.

- 21 - Closed end, grounded 1/8" no flexible tube
- 30 - Open end, grounded 3/16" no flexible tube
- 31 - Closed end, grounded 3/16" no flexible tube
- 34 - Closed end, ungrounded 3/16" no flexible tube

Field 7. COLD END TERMINATION

- 3 - Solid pin quick disconnect plug(s)
- 4 - Solid pin quick disconnect plug(s) with mating jack(s)
- 7 - Quick disconnect jack(s)
- 8 - Miniature plastic weatherproof head
- A - 3" lead with 1/4" stripped ends, no spring or ferrule; or, specify lead length on order.*
- B - 2-1/2" lead with lugs, no spring or ferrule; or, specify lead length on order.
- C - Hollow pin quick disconnect plug(s), Type J only
- D - Hollow pin quick disc. plug(s) with jack(s), Type J only

Fields 8, 9. RIGID LENGTH (DIMENSION "X")

XX - Enter "X" length in whole inches

Fields 10, 11, 12. RESERVED

Field 13. ATTACHING DEVICE

- 0 - None
- 2 - 1/8" NPT compression fitting, nickel plated brass
- 3 - 1/8" NPT compression fitting, stainless steel
- 4 - Fixed bayonet fitting on 3/16" tube, or adjustable bayonet on 1/8" tube ("X" must be at least 3")

Note: maximum pressure 100 psi for compression fittings

Fields 14, 15. LOCK DEPTH (DIMENSION "Z")

- 00 - None. Compression fitting or adjustable bayonet
- ZZ - Fixed bayonet styles, see table below.

01 1-1/2"	04 3"	31 4-3/8"	10 6"
14 1-5/8"	23 3-1/8"	07 4-1/2"	41 6-1/8"
15 1-3/4"	24 3-1/4"	32 4-5/8"	42 6-1/4"
16 1-7/8"	05 3-1/2"	33 4-3/4"	43 6-3/8"
02 2"	25 3-3/8"	34 4-7/8"	11 6-1/2"
17 2-1/8"	05 3-1/2"	08 5"	44 6-5/8"
18 2-1/4"	26 3-5/8"	35 5-1/8"	45 6-3/4"
19 2-3/8"	27 3-3/4"	36 5-1/4"	46 6-7/8"
03 2-1/2"	28 3-7/8"	37 5-3/8"	12 7"
20 2-5/8"	06 4"	09 5-1/2"	47 7-1/8"
21 2-3/4"	29 4-1/8"	38 5-5/8"	48 7-1/4"
22 2-7/8"	30 4-1/4"	39 5-3/4"	49 7-3/8"
99 - Not listed; specify on order		40 5-7/8"	13 7-1/2"

Fixed or Adjustable RTD

Rigid or Flexible RTD Fixed or Adjustable Depth Bushing Mount

Introduction

Bushing mounted RTDs are available with rigid tube or flexible armor. The process mounting bushing can be brazed on the tube in the position ("U" dimension) specified on your order; or you can order an adjustable bushing held by a compression fitting. The adjustable bushing allows you to set the immersion depth when you install the probe.

Ordering Information

Model No. P - - - **- 0 0**
 Field No. 1 2 3 4 5 6 7 8 9 10 11 12 13 14 15

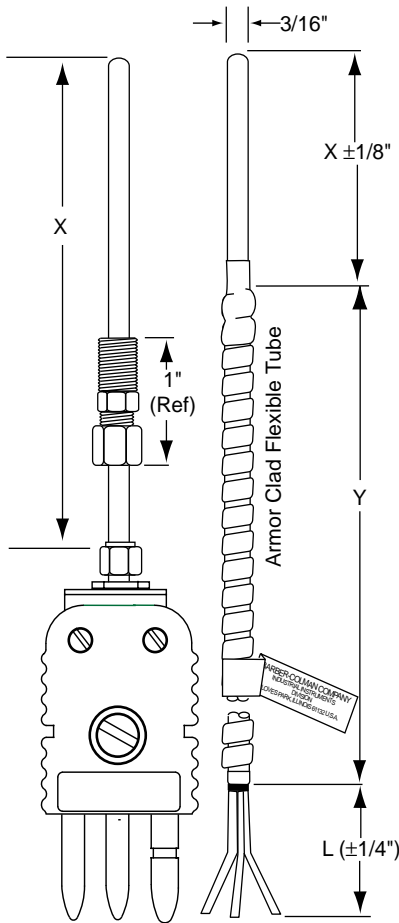

Fields 1, 2. BASE MODEL

- P5 - 0.00391 $\Omega/\Omega/^\circ\text{C}$ Resistance Temperature Detector
- P7 - 0.00385 $\Omega/\Omega/^\circ\text{C}$ Resistance Temperature Detector
- P8 - 0.00385 $\Omega/\Omega/^\circ\text{C}$ RTD and Type J Thermocouple

Field 3. ELEMENT

	Accuracy (at 300°F)	Temp Rating	Wires
1 -	0.25%	500°F	3
2 -	0.10%	932°F	3
3 -	0.25%	932°F	3
4 -	0.10%	500°F	2
5 -	0.25%	932°F	2
6 -	0.10%	500°F	3

Field 4. NUMBER OF ELEMENTS; CONFIGURATION

- 1 - Single element, straight
- 2 - Single element, 90°
- 3 - Single element, 45°
- 4 - Dual element, straight*
- 5 - Dual element, 90°*
- 6 - Dual element, 45°*

*Available only with Field 3 code 4 or 5

Fixed or Adjustable RTD

Ordering Information (continued)

Fields 5, 6. PROTECTION

☞ Determine length by completing Fields 10, 11, 12.

Model P5 or Model P7

- 31 - No lead, or lead with stainless steel overbraid
- 33 - Leadwire with flexible armor

Model P8

- 31 - No lead, or lead with stainless steel overbraid
- 33 - Leadwire with flexible armor

Field 7. COLD END TERMINATION

- 0 - 2-1/2" split leads, ends stripped
- 1 - 2-1/2" split leads, spade lugs
- 2 - 2-1/2" split leads, spade lugs, 1/2" NPS box connector with lock nut
- 3 - Solid pin quick disconnect plug
- 4 - Solid pin quick disconnect plug with mating jack

Extended Lead (DIMENSION "L")

- F - 12", split ends stripped
 - G - 24", split ends stripped
 - H - 48", split ends stripped
 - J - 96", split ends stripped
 - K - 144", split ends stripped
- For other lengths, consult factory.

Fields 8, 9. RIGID LENGTH (DIMENSION "X")*

XX - Length in whole inches (02" minimum)

*Total assembly length over 4 feet introduces an offset in sensed temperature of approximately 1-1/4°F per 10 feet over 4 feet.

Fields 10, 11, 12. FLEXIBLE LENGTH (DIMENSION "Y")*

☞ Complete these Fields to determine length for Fields 5, 6.

- 000 - None. Used only with Field 7, code 3 or 4
- YYY - Actual length in whole inches

Field 13. ATTACHING DEVICE (DIMENSION "U")

- 0 - None
- 2 - 1/8" nickel plated brass compression fitting
- 3 - 1/8" stainless steel compression fitting
- 8 - Brazed 1/8" NPT fitting for fixed depth. See illustration. Specify "U" dimension on order.
- 9 - Other stocked compression fittings or bushings (consult factory)

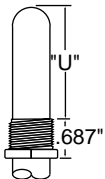

Fields 14, 15. RESERVED

Ring, Lug T/C

Ring Type and Lug Type Thermocouples

Introduction

These thermocouples measure surface temperature – such as a barrel or mold. The ring or lug is placed over a threaded stud and secured with a nut. A ring or lug thermocouple is often connected in parallel with another thermocouple to control at average temperature between barrel surface and some point inside the barrel. Both thermocouples must be the same type, and have the same resistance. This arrangement produces closer control for more uniform temperature of the plastic melt.

Ordering Information

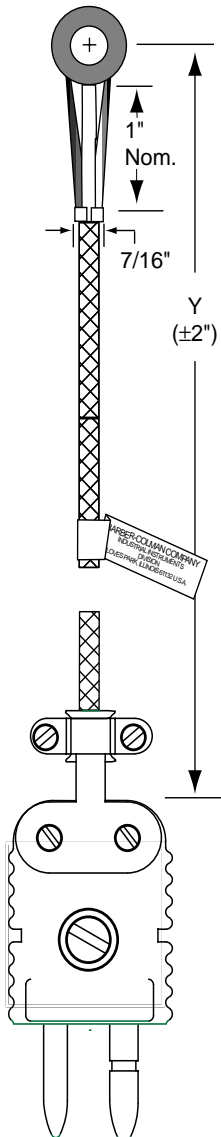

Model No. P **1** - **00** - - **7** -

Field No. 1 2 3 4 5 6 7 8 9 10 11 12 13 14 15

Field 1. BASE MODEL

P - Plastics industry

Fields 2, 3. THERMOCOUPLE TYPE

Fiberglass insulation unless otherwise stated.

☞ Determine length by completing Fields 10, 11, 12.

Type	Description
01 - J	20 gauge, solid
02 - J	24 gauge, solid
07 - J	20 gauge, stainless steel overbraid
11 - J	20 gauge, strand, stainless steel overbraid
12 - J	20 gauge, strand
13 - J	24 gauge, solid, stainless steel overbraid
15 - J	24 gauge, strand, stainless steel overbraid
26 - J	24 gauge, strand
05 - K	20 gauge, solid
08 - K	20 gauge, stainless steel overbraid
19 - K	24 gauge, solid
20 - K	20 gauge, strand
24 - K	24 gauge, solid, stainless steel overbraid

Fields 4, 5, 6. RESERVED

Ring, Lug T/C

Ordering Information (continued)

Field 7. COLD END TERMINATION

- 0 - 2-1/2" split leads, ends stripped
- 1 - 2-1/2" split leads, spade lugs
- 2 - 2-1/2" split leads, spade lugs, 1/2" NPS box connector with lock nut
- 3 - Solid pin quick disconnect plug(s)
- 4 - Solid pin quick disconnect plug(s) with mating jack(s)
- 7 - Quick disconnect jack(s)
- C - Hollow pin quick disconnect plug(s), Type J only
- D - Hollow pin quick disconnect plug(s) with jack(s), Type J only

Fields 8, 9. RESERVED

Fields 10, 11, 12. FLEXIBLE LENGTH (DIMENSION "Y")

- ☞ Complete these Fields to determine length for Fields 2, 3
- YYY - Enter "Y" length in whole inches; minimum 018"

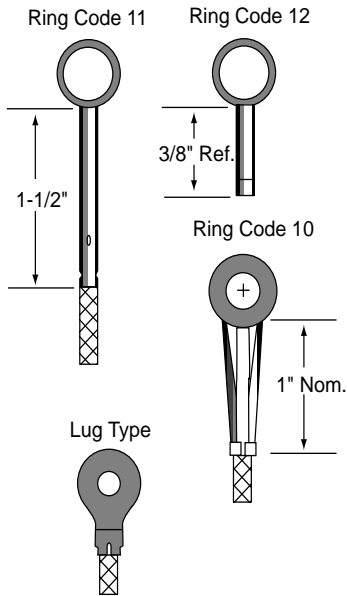

Field 13. RESERVED

Fields 14, 15. RING OR LUG TYPE

Lugs

- 01 - #8 screw (.173" i.d.) 3/8" o.d.
- 02 - #10 screw (.204" i.d.) 15/32" o.d.
- 03 - 1/4" screw 17/32" o.d.
- 04 - 5/16" screw 17/32" o.d.
- 05 - 3/8" screw 3/4" o.d.
- 06 - 1/2" screw 3/4" o.d.

Rings

- 10 - 3/8" screw 13/16 o.d. 3/32" thick
- 11 - #10 screw 5/16" o.d. 1/4" thick; stainless steel
- 12* - #10 screw 5/16" o.d. 5/32" thick

*Fields 2, 3 codes 01, 02, 13, 19 and 24 only

Nozzle Melt T/C

Nozzle Melt Thermocouple for Injection Molding

Introduction

The nozzle melt thermocouple is designed for injection molders. This stainless steel thermocouple fits on the nozzle of an injection molding machine and senses the actual temperature of the plastic just before it is injected into the mold. This allows accurate control of the nozzle. Direct contact is the most reliable way to measure the melt temperature.

The thermocouple seals against the high pressures encountered in the nozzle. The mounting rotates, simplifying installation and eliminating the twisting of the leads. Quick disconnect plugs may be ordered.

This thermocouple will withstand the abuse of long production runs. Start-up time is minimized with melt temperature conditions quickly established. Two Type J sensor styles are available: 24 gauge strand, fiberglass insulated with stainless steel overbraid; and solid, magnesium oxide insulated, stainless steel sheathed probe with transition to 20 gauge strand, fiberglass insulated wire. Since the MgO, SS sheathed probe can be formed over a mandrel as small as 1/4", this style is normally sold straight

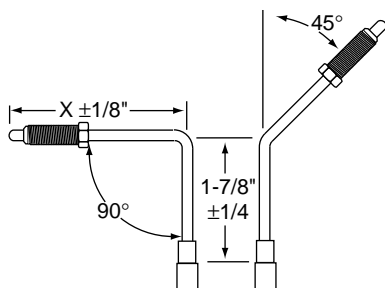
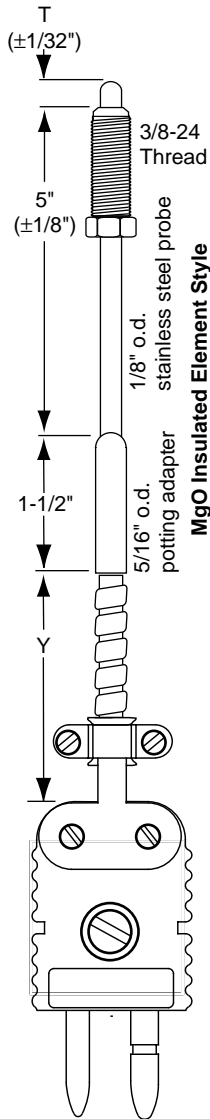

Style	Response Time	Pressure Rating at 750°F
Magnesium Oxide	0.5 second	40,000 psi
Tubing and Fiberglass	0.9 second	40,000 psi

- Temperature rating to 750°F Excluding Cold End Termination
- Small Size – No Interference With Mold Platens
- Easy Installation – Mounting Nut Rotates; No Lead Twisting
- Improved Product Quality; Faster Setup Time

Model No. P - - - **5** -

Field No. 1 2 3 4 5 6 7 8 9 10 11 12 13 14 15

Field 1. BASE MODEL

P - Plastics industry

Fields 2, 3. THERMOCOUPLE TYPE

☛ Determine length (Y + L) by completing Fields 10, 11, 12, and Field 7.

Type Description

- 15 - J 24 gauge, strand, stainless steel overbraid
- 16 - J MgO insulated with transition to 20 ga. strand

Field 4. NUMBER OF ELEMENTS AND PROBE CONFIGURATION

- 1 - Single element, straight
 - 2 - Single element, 90°
 - 3 - Single element, 45°
- Fields 2, 3, Code 15 only**

Nozzle Melt T/C

Ordering Information (continued)

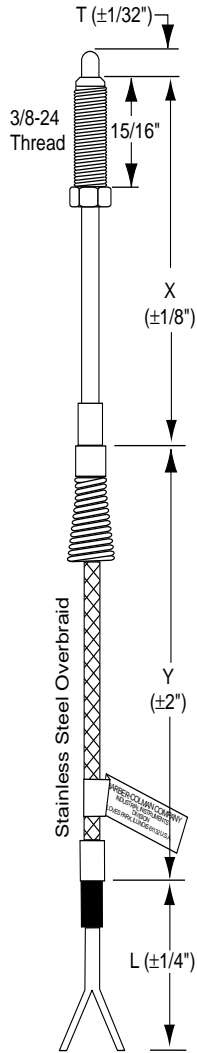

Fields 5, 6. JUNCTION STYLE, PROBE O.D., LEAD PROTECTION

Determine length by completing Fields 10, 11, 12

Fields 2,3, Code 15 only

- 21 - Closed end, grounded 1/8" no flexible tube
- 23 - Closed end, grounded 1/8" flexible tube

Fields 2, 3, Code 16 only

- 41 - Closed end, grounded 1/8" flexible tube
- 42 - Closed end, ungrounded 1/8" flexible tube

Field 7. COLD END TERMINATION

- 0 - 2-1/2" split leads, ends stripped
- 1 - 2-1/2" split leads, spade lugs
- 2 - 2-1/2" split leads, spade lugs, 1/2" NPS box connector with lock nut
- 3 - Solid pin quick disconnect plug(s)
- 4 - Solid pin quick disconnect plug(s) with mating jack(s)
- 7 - Quick disconnect jack(s)
- C - Hollow pin quick disconnect plug(s), Type J only
- D - Hollow pin quick disconnect plug(s) with jack(s), Type J only

Extended Lead (DIMENSION "L")

Complete this Field to determine length for Fields 2, 3

- F - 12", split ends stripped In Fields 2, 3
 - G - 24", split ends stripped In Fields 2, 3
 - H - 48", split ends stripped In Fields 2, 3
 - J - 96", split ends stripped In Fields 2, 3
 - K - 144", split ends stripped In Fields 2, 3
- For other lengths, consult factory

Fields 8, 9. RIGID LENGTH (DIMENSION "X")

- 00 - 5" (required when Fields 2, 3 is code 16)
- 01 - 1-1/2"
- 02 - 1-3/4"
- 03 - 2"
- 04 - 2-1/4"
- 05 - 2-1/2"
- 99 - Other than above. Specify in whole inches on order

Fields 10, 11, 12. FLEXIBLE LENGTH (DIMENSION "Y")

Complete these Fields to determine length for Fields 2, 3; and 5, 6
 YYY - Enter actual "Y" length in whole inches; minimum 018"

Field 13. RESERVED

Fields 14, 15. TIP LENGTH (DIMENSION "T")

- 01 - 1/8" (recommended)
- 02 - 3/16"
- 03 - 1/4"

Bolt Blank (Part No.11-03359)

Plugs mounting hole when sensor removed

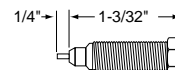

Non-Immersion Nozzle T/C

Non-Immersion Nozzle Thermocouple

Introduction

The non-immersion nozzle melt single element thermocouple is available with 1/4-28 thread, stainless steel, rotatable fitting. The probe is 1/8", closed end grounded. The leads are available with stainless steel overbraid sheath. The thermocouple measures the temperature in a threaded shallow drilled hole.

Ordering Information

Model No. P **1 - 2 1** **0 0 -** **- 8 - 0 0**
 Field No. 1 2 3 4 5 6 7 8 9 10 11 12 13 14 15

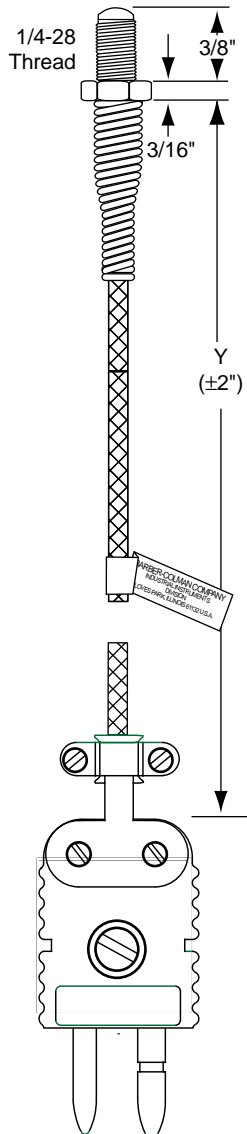

Field 1. BASE MODEL

P - Plastics industry

Fields 2, 3. THERMOCOUPLE TYPE

☞ Determine length by completing Fields 10, 11, 12.

Type	Description
02 - J	24 gauge, solid
13 - J	24 gauge, solid, stainless steel overbraid
15 - J	24 gauge, strand, stainless steel overbraid
26 - J	24 gauge, strand

Fields 4, 5, 6. RESERVED

Field 7. COLD END TERMINATION

- 0 - 2-1/2" split leads, ends stripped
- 1 - 2-1/2" split leads, spade lugs
- 2 - 2-1/2" split leads, spade lugs, 1/2" NPS box connector with lock nut
- 3 - Solid pin quick disconnect plug(s)
- 4 - Solid pin quick disconnect plug(s) with mating jack(s)
- 7 - Quick disconnect jack(s)
- C - Hollow pin quick disconnect plug(s), Type J only
- D - Hollow pin quick disconnect plug(s) with jack(s), Type J only

Fields 8, 9. RESERVED

Fields 10, 11, 12. FLEXIBLE LENGTH (DIMENSION "Y")

☞ Complete these Fields to determine length for Fields 2, 3
 YYY - Enter actual "Y" length in whole inches; minimum 018"

Fields 13, 14, 15. RESERVED

Non-Immersion Nozzle RTD

Non-Immersion Nozzle RTD

Introduction

Single Platinum 100 ohms, RTD element.

The tolerances shown below apply to all three lead probes, and two lead probes whose total length does not exceed 48". Tolerances for two lead probes longer than 48" are increased .03 ohm for each 12" over 48" length:

Temperature range: -148° to 932°F (-100 to 500°C), reduced to 350°F (176°C) for plug connector.

Insulation resistance: 100 megohms minimum at 100 Vdc. Leads to case.

Ordering Information

Model No. P **1** - **0** **0** - **- 5 - 0**
 Field No. 1 2 3 4 5 6 7 8 9 10 11 12 13 14 15

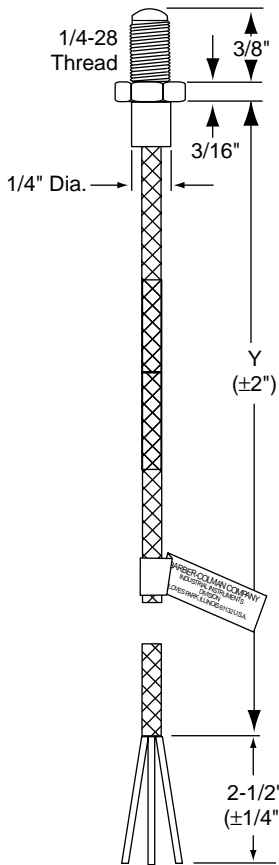

Fields 1, 2. BASE MODEL

- P5 - 0.00391 $\Omega/\Omega/^\circ\text{C}$ Nozzle Resistance Temperature Detector
- P7 - 0.00385 $\Omega/\Omega/^\circ\text{C}$ Nozzle Resistance Temperature Detector

Field 3. ELEMENT

Determine length by completing Fields 10, 11, 12

	<u>Accuracy (at 300°F)</u>	<u>Temp Rating</u>	<u>Wires</u>
2 -	0.10%	932°F	3
5 -	0.25%	932°F	2

Fields 4, 5, 6. RESERVED

Field 7. COLD END TERMINATION

- 0 - 2-1/2" split leads, ends stripped
- 1 - 2-1/2" split leads, spade lugs
- 2 - 2-1/2" split leads, spade lugs, 1/2" NPS box connector with lock nut
- 3 - Solid pin quick disconnect plug
- 4 - Solid pin quick disconnect plug with mating jack

Fields 8, 9. RESERVED

Fields 10, 11, 12. FLEXIBLE LENGTH (DIMENSION "Y")

Complete these Fields to determine length for Field 3
 YYY - Actual length in whole inches

Fields 13, 14, 15. RESERVED

Melt Bolt T/C, Fixed

Melt Bolt Thermocouple Fixed Depth Immersion

Introduction

Melt bolt thermocouples are used on extruders and injection molding machines. The immersed tip provides direct melt temperature measurement. Two styles are available:

- MgO insulated wire in a full length, rigid stainless steel probe
- Fiberglass insulated wire in a rigid stainless steel probe with a flexible, armor clad protection tube

Standard bolt lengths are 3", 4" and 6". Other lengths are available. Typically, 2" of protection tube ("Y" dimension) beyond the bolt head is satisfactory.

Ordering Information

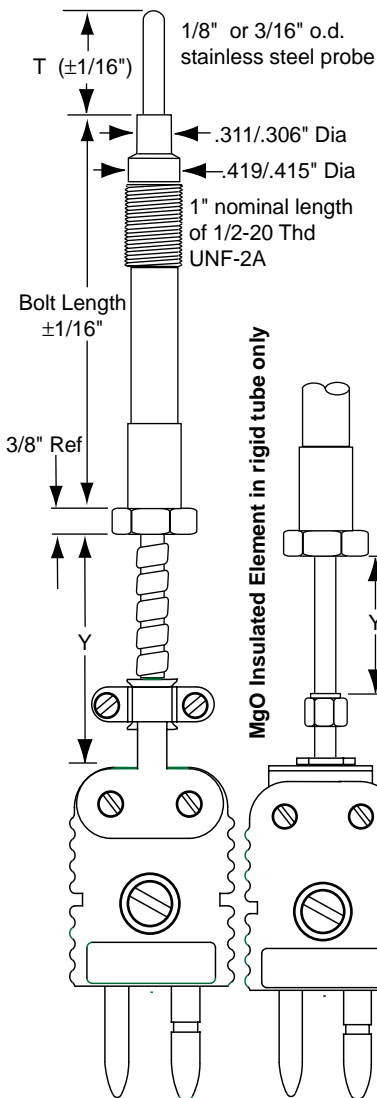

Model No. P - - - 1 -

Field No. 1 2 3 4 - 5 6 7 8 9 - 10 11 12 13 14 15

Field 1. BASE MODEL
P - Plastics industry

Fields 2, 3, 4, 5, 6. THERMOCOUPLE TYPE, NUMBER OF ELEMENTS, AND JUNCTION STYLE, PROBE O.D., LEAD PROTECTION

☞ Determine length (Y + L) by completing Fields 10, 11, 12, and Field 7.

	Type	Gauge	Wire	o.d.	End
Fiberglass Insulation with Flexible Tube, Single Element					
011-51	J	20	solid	3/16"	closed, grounded
021-41	J	24	solid	1/8"	closed, grounded
021-51	J	24	solid	3/16"	closed, grounded
Fiberglass Insulation with Flexible Tube, Dual Element					
024-51	J	24		3/16"	closed, grounded

MgO Insulation, Single Element					
161-41	J	1/8" o.d.			closed, grounded
161-42	J	1/8" o.d.			closed, ungrounded
161-43	J	1/8" o.d.			open, ungrounded
161-51	J	3/16" o.d.			closed, grounded
161-52	J	3/16" o.d.			closed, ungrounded
161-53	J	3/16" o.d.			open, ungrounded

MgO Insulation, Dual Element					
164-41	J	1/8" o.d.			closed, grounded
164-42	J	1/8" o.d.			common, closed, ungrounded
164-44	J	1/8" o.d.			common, exposed
164-45	J	1/8" o.d.			isolated, exposed
164-51	J	3/16" o.d.			closed, grounded
164-52	J	3/16" o.d.			common, closed, ungrounded
164-54	J	3/16" o.d.			common, exposed
164-55	J	3/16" o.d.			isolated, exposed

Melt Bolt T/C, Fixed

Ordering Information (continued)

Field 7. COLD END TERMINATION

- 0 - 2-1/2" split leads, ends stripped*
- 1 - 2-1/2" split leads, spade lugs*
- 2 - 2-1/2" split leads, spade lugs, 1/2" NPS box connector with lock nut*
- 3 - Solid pin quick disconnect plug(s)
- 4 - Solid pin quick disconnect plug(s) with mating jack(s)
- 7 - Quick disconnect jack(s)
- C - Hollow pin quick disconnect plug(s), Type J only
- D - Hollow pin quick disconnect plug(s) with jack(s), Type J only

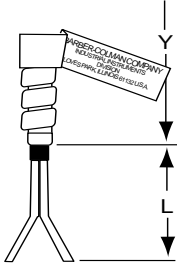

Extended Lead (DIMENSION "L")*

☞ Complete this Field to determine length for Fields 2, 3, 4, 5, 6

- F - 12", split ends stripped
- G - 24", split ends stripped
- H - 48", split ends stripped
- J - 96", split ends stripped
- K - 144", split ends stripped

For other lengths, consult factory

*not available on thermocouples with MgO insulation

Fields 8, 9. BOLT LENGTH

- 03 - 3"
- 04 - 4"
- 06 - 6"
- 98 - 1-7/16" to 1-7/8" – specify on order
- 99 - 2-1/4" to 12" – specify on order

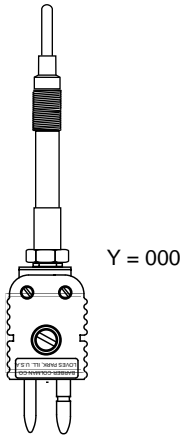

Fields 10, 11, 12. FLEXIBLE LENGTH (DIMENSION "Y")

☞ Complete these Fields to determine length for Fields 2, 3, 4, 5, 6

Note: "Y" length of MgO insulated thermocouple not flexible.

YYY- Enter actual "Y" length.

000 - No lead. Cold end termination plug (Field 7, code 3 or 4) on end of bolt (see illustration). Not available on dual element thermocouple with MgO insulation.

Field 13. RESERVED

Fields 14, 15. TIP LENGTH (DIMENSION "T")

- 00 - None – flush
- 01 - 1/8"
- 03 - 1/4"
- 05 - 1/2"
- 07 - 3/4"
- 09 - 1"
- 99 - Not listed. Specify on order. 1/16" minimum for thermocouples with MgO insulation; 1/8" minimum for thermocouples with fiberglass insulation.

Blank bolts are available to seal holes in extruder after the thermocouple has been removed. Dimensions illustrated here are typical of blank bolts and immersion thermocouples.

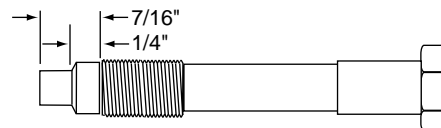

Length	Part Number
3" bolt	A-09759-101
4" bolt	A-09760-101
6" bolt	A-09761-101

Melt Bolt RTD, Fixed

Melt Bolt RTD Fixed Depth Immersion

Introduction

Platinum 100 ohms, RTD element . The tolerances shown below apply to all three lead probes, and two lead probes whose total length does not exceed 48". Tolerances for two lead probes longer than 48" are increased .03 ohm for each 12" over 48" length:

Temperature range: -148° to 932°F (-100 to 500°C), reduced to 350°F (176°C) for plug connector. Insulation resistance: 100 megohms minimum at 100 Vdc; leads to case. Pressure capacity: 10,000 PSI on sensing element.

Ordering Information

Model No. P - **3** - - **1** -

Field No. 1 2 3 4 5 6 7 8 9 10 11 12 13 14 15

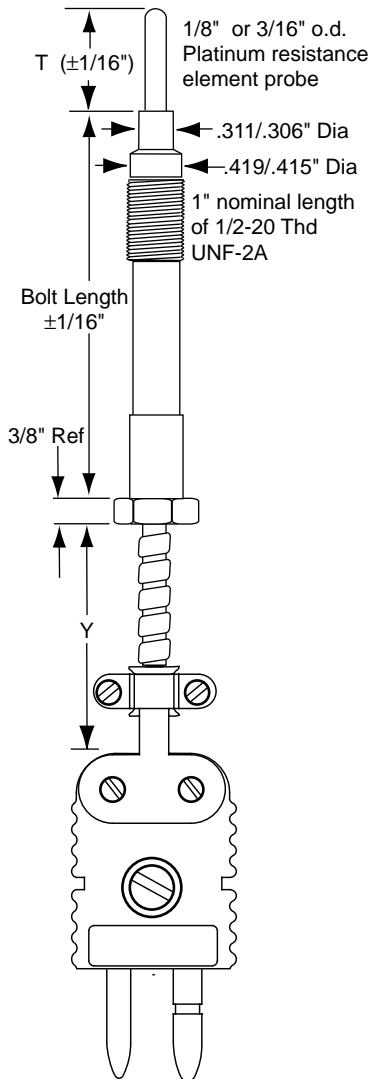

Fields 1, 2. BASE MODEL

P5 - 0.00391 $\Omega/\Omega/^\circ\text{C}$ Melt Bolt Resistance Temperature Detector
P7 - 0.00385 $\Omega/\Omega/^\circ\text{C}$ Melt Bolt Resistance Temperature Detector

Fields 3, 4. ELEMENT

☞ Determine length by completing Fields 10, 11, 12

	Accuracy	Temp Rating	Wires	Elements
21 -	0.10%	932°F	3	Single
31 -	0.25%	932°F	3	Single
51 -	0.25%	932°F	2	Single
54 -	0.25%	932°F	2	Dual

Fields 5, 6. PROTECTION

42 - 1/8" diameter, closed end (Not available with Fields 3, 4, code 54)
52 - 3/16" diameter closed end

Field 7. RESERVED

Fields 8, 9. BOLT LENGTH

03 - 3"
04 - 4"
06 - 6"
99 - None of the above. Specify on order

Fields 10, 11, 12. FLEXIBLE LENGTH (DIMENSION "Y")*

☞ Complete these Fields to determine length for Fields 3, 4
YYY - Actual length in whole inches

Field 13. RESERVED

Fields 14, 15. PROBE LENGTH (DIMENSION "T")

Note: 1/2" maximum for 1/8" o.d. probe; 5/8" maximum for 3/16" o.d. dual probe
00 - Flush (3/16" o.d. only)
05 - 1/2"
07 - 3/4"
09 - 1"
99 - None of the above. Specify on order.

Retractable Melt Bolt T/C

Retractable Melt Bolt Thermocouple

Introduction

The retractable melt bolt thermocouple measures melt stream temperature under working conditions. It can be installed wherever standard melt bolt thermocouples are used. Bolt lengths of 3", 5" and 7" are available. A ceramic insulator in the bolt tip reduces conduction from the barrel.

The probe is fitted with a positive stop to prohibit removal unless the hex nut is disengaged from the bolt. The 1/8" diameter probe provides minimum barrier to melt flow. You can adjust the tip of the probe from 1/8" to 1" on standard models; other depth ranges are available under special order. The element leads are MgO insulated; the measuring junction is exposed for fast response and rated to 900°F. This thermocouple is available with either single or dual Type J elements. Replacement elements are available.

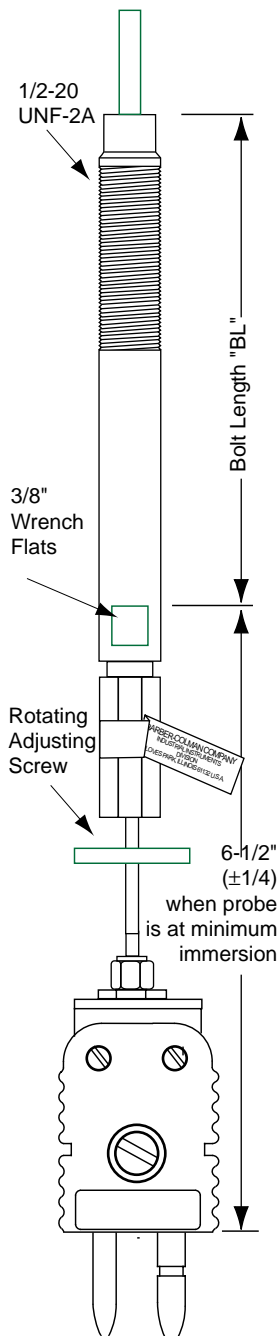

Size Model Number

Single Element

3"	A-10528-100-0-03
5"	A-10528-100-0-05
7"	A-10528-100-0-07

Replacement Element

A-10529-100-0-03
A-10529-100-0-05
A-10529-100-0-07

Dual Elements

3"	A-10528-100-1-03
5"	A-10528-100-1-05
7"	A-10528-100-1-07

A-10529-100-1-03
A-10529-100-1-05
A-10529-100-1-07

Options

Support Tube

The thermocouple can be ordered with a 3/16" o.d. support tube surrounding the probe for added strength. This option may be effective under certain flow conditions, or extended immersion. Simply specify "with 3/16" support tube" on order.

Special Immersion Range

0 to 7/8"

Specify "special immersion of 0 to 7/8 inches" on order.

Specify "special immersion of _____ to _____ inches" on order.

Special Bolt Length Consult Factory

Note: Thermocouples with options will be assigned a unique model number at the factory for future reference.

Accessories

Accessories

Wire Grip Fitting.

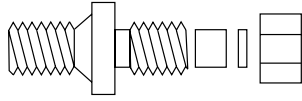

Provides strain relief and moisture proof protection for extension wires from 1/8" to 3/8" o.d. Contains 1/4 NPT brass body, nut, two sizes of back-up washers and four assorted sizes of elastomer grommets. Weight 1 oz.

Part Number PF75-J0200-375

Water Tight Wire Fitting

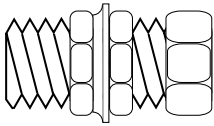

Liquid tight Nylon gasket for wire diameter of .219 to .375" mounting in 1/2" conduit knockout. Weight 1 oz.

Part Number A-11426

Terminal Connector and Locknut

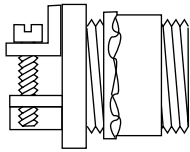

Made for standard terminal junction box. Connector has two clamp screws for attaching to thermocouple protection tube or flexible conduit. Weight 1/2 oz.

Part Number 34-400-100

Butt Connector

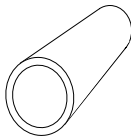

Crimp-on terminal for use on 22 to 18 gauge thermocouple wires to insure positive screw connection. Weight 1 oz.

Part Number 34-00774

Stainless Steel Flexible Armor Cable

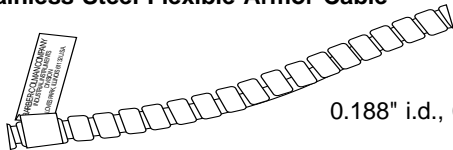

0.188" i.d., 0.266" o.d. Weight 0.6 ounce per foot.

Part Number R6-00821-100-0-00

Adjustable Bayonet Lock Attachment

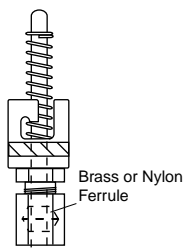

This device can be fitted over any 1/8" o.d. plain end thermocouple and adjusted to the selected immersion depth by tightening the compression fitting. With a suitable adapter, any immersion depth over 1/2" can be selected.

The fitting is shipped with both a nylon and brass ferrule. Nylon permits readjustment, but should not be exposed to temperature over 250°F. The brass ferrule cannot be adjusted after it is set. It is suitable for temperatures up to 900°F.

Part Number A-05205-000-0-00

Accessories

Stainless Steel Flexible Armor Cable Assemblies

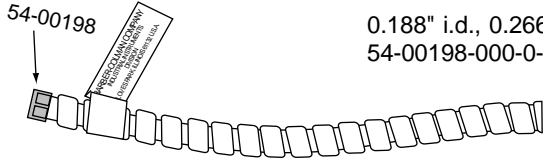

0.188" i.d., 0.266" o.d. Weight 0.6 ounce per foot.
54-00198-000-0-00 brass eyelet crimped on termination end.

Part Number

A-09830-000-0-12	12" long
A-09830-000-0-24	24" long
A-09830-000-0-36	36" long
A-09830-000-0-48	48" long
A-09830-000-0-60	60" long
A-09830-000-0-72	72" long
A-09830-000-0-84	84" long
A-09830-000-0-96	96" long
A-09830-000-1-20	120" long
A-09830-000-1-44	144" long

Brass Eyelet

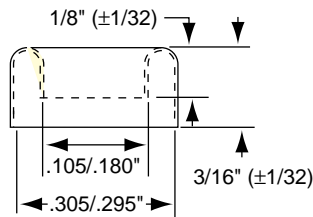

To be inserted in termination end of flexible armor to protect lead wires from rough edge of armor cable. Crimping not needed. Weight 1 ounce.

Part Number 54-00198-000-0-00

Relief Spring

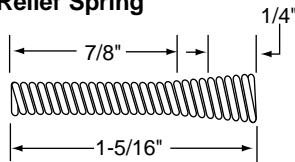

Weight 1 ounce.

Part Number 25-00360-000-0-00, 1/4" o.d.
Part Number 25-00361-000-0-00, 5/16" o.d.

Probe with Bayonet Lock Cap

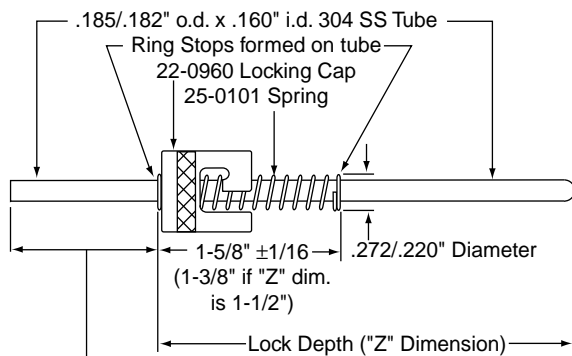

1" for straight probes; 2-3/4" for 45° and 90° probes
(angles bent at final assembly)

Part Number

"Z" Dimension

Straight Probes

A-09831-000-0-01	1-1/2"
A-09831-000-0-04	3"
A-09831-000-0-06	4"
A-09831-000-0-08	5"
A-09831-000-0-10	6"
A-09831-000-0-13	7-1/2"

45° and 90° Angle Probes

A-09933-000-0-01	1-1/2"
A-09933-000-0-04	3"
A-09933-000-0-06	4"
A-09933-000-0-08	5"
A-09933-000-0-10	6"
A-09933-000-0-13	7-1/2"

Accessories

Bayonet Lock Adapters

To determine the nominal adapter length, proceed as follows:

Adapters with 1/8 NPT: "Z" dimension minus hole depth minus 3/8".

Adapters with 3/8-24 thread: "Z" dimension minus hole depth minus 1/4".

Round the adapter up to the nearest 1/8".

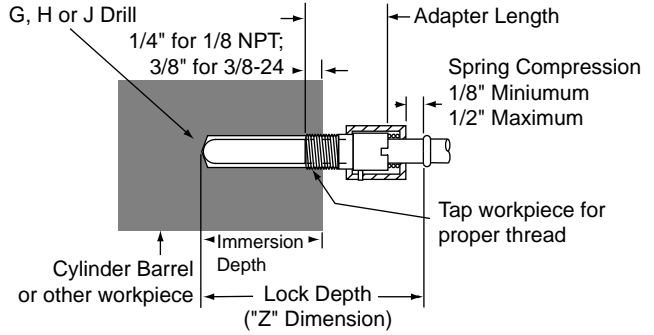

Adapters with Hex Bushing

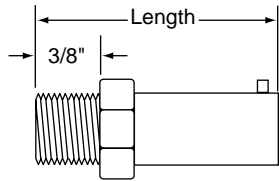

Part Number

Length Thread

A-04790-000-0-00	7/8"	3/8-24
A-04791-000-0-00	1-1/8"	3/8-24
A-04792-000-0-00	1-1/2"	3/8-24

Adapters with Slot – Common Lengths

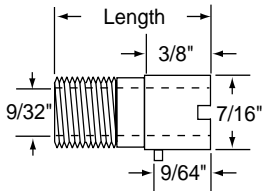

A-02709-001-0-00	13/16"	1/8 NPT
A-03076-001-0-00	15/16"	3/8-24
A-04017-000-0-00	1"	1/8 NPT
A-03077-001-0-00	1-1/2"	1/8 NPT
A-03179-000-0-00	1-1/2"	3/8-24
A-03092-001-0-00	2"	1/8 NPT
A-11124-000-0-00	2"	12-1 MM
A-03414-000-0-00	2-1/2"	1/8 NPT

Adapters with Slot – Custom Lengths (Minimum ten adapters per order)

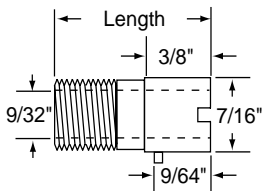

A-11355-000-0-16	2"	1/8 NPT (Order A-03092-001-0-00)
A-11356-000-0-16	2"	3/8-24
A-11355-000-0-18	2-1/4"	1/8 NPT
A-11356-000-0-18	2-1/4"	3/8-24
A-11355-000-0-20	2-1/2"	1/8 NPT
A-11356-000-0-20	2-1/2"	3/8-24
A-11355-000-0-22	2-3/4"	1/8 NPT
A-11356-000-0-22	2-3/4"	3/8-24
A-11355-000-0-24	3"	1/8 NPT

Accessories

Adapters with Slot – Custom Lengths (Continued) (Minimum ten adapters per order)

<u>Part Number</u>	<u>Length</u>	<u>Thread</u>
A-11356-000-0-24	3"	3/8-24
A-11355-000-0-26	3-1/4"	1/8 NPT
A-11356-000-0-26	3-1/4"	3/8-24
A-11355-000-0-28	3-1/2"	1/8 NPT
A-11356-000-0-28	3-1/2"	3/8-24
A-11355-000-0-30	3-3/4"	1/8 NPT
A-11356-000-0-30	3-3/4"	3/8-24
A-11355-000-0-32	4"	1/8 NPT
A-11356-000-0-32	4"	3/8-24
A-11355-000-0-34	4-1/4"	1/8 NPT
A-11356-000-0-34	4-1/4"	3/8-24
A-11355-000-0-36	4-1/2"	1/8 NPT
A-11356-000-0-36	4-1/2"	3/8-24
A-11355-000-0-38	4-3/4"	1/8 NPT
A-11356-000-0-38	4-3/4"	3/8-24
A-11355-000-0-40	5"	1/8 NPT
A-11356-000-0-40	5"	3/8-24
A-11355-000-0-42	5-1/4"	1/8 NPT
A-11356-000-0-42	5-1/4"	3/8-24
A-11355-000-0-44	5-1/2"	1/8 NPT
A-11356-000-0-44	5-1/2"	3/8-24
A-11355-000-0-46	5-3/4"	1/8 NPT
A-11356-000-0-46	5-3/4"	3/8-24
A-11355-000-0-48	6"	1/8 NPT
A-11356-000-0-48	6"	3/8-24
A-11355-000-0-50	6-1/4"	1/8 NPT
A-11356-000-0-50	6-1/4"	3/8-24
A-11355-000-0-52	6-1/2"	1/8 NPT
A-11356-000-0-52	6-1/2"	3/8-24
A-11355-000-0-54	6-3/4"	1/8 NPT
A-11356-000-0-54	6-3/4"	3/8-24
A-11355-000-0-56	7"	1/8 NPT
A-11356-000-0-56	7"	3/8-24
A-11355-000-0-58	7-1/4"	1/8 NPT
A-11356-000-0-58	7-1/4"	3/8-24
A-11355-000-0-60	7-1/2"	1/8 NPT
A-11356-000-0-60	7-1/2"	3/8-24
A-11355-000-0-62	7-3/4"	1/8 NPT
A-11356-000-0-62	7-3/4"	3/8-24
A-11355-000-0-64	8"	1/8 NPT
A-11356-000-0-64	8"	3/8-24
A-11355-000-0-66	8-1/4"	1/8 NPT
A-11356-000-0-66	8-1/4"	3/8-24
A-11355-000-0-68	8-1/2"	1/8 NPT
A-11356-000-0-68	8-1/2"	3/8-24
A-11355-000-0-70	8-3/4"	1/8 NPT
A-11356-000-0-70	8-3/4"	3/8-24
A-11355-000-0-72	9"	1/8 NPT
A-11356-000-0-72	9"	3/8-24
A-11355-000-0-74	9-1/4"	1/8 NPT
A-11356-000-0-74	9-1/4"	3/8-24
A-11355-000-0-76	9-1/2"	1/8 NPT
A-11356-000-0-76	9-1/2"	3/8-24
A-11355-000-0-78	9-3/4"	1/8 NPT
A-11356-000-0-78	9-3/4"	3/8-24

Accessories

Adapters with Slot – Custom Lengths (Continued) (Minimum ten adapters per order)

Part Number	Length	Thread
A-11355-000-0-80	10"	1/8 NPT
A-11356-000-0-80	10"	3/8-24
A-11355-000-0-82	10-1/4"	1/8 NPT
A-11356-000-0-82	10-1/4"	3/8-24
A-11355-000-0-84	10-1/2"	1/8 NPT
A-11356-000-0-84	10-1/2"	3/8-24
A-11355-000-0-86	10-3/4"	1/8 NPT
A-11356-000-0-86	10-3/4"	3/8-24
A-11355-000-0-88	11"	1/8 NPT
A-11356-000-0-88	11"	3/8-24
A-11355-000-0-90	11-1/4"	1/8 NPT
A-11356-000-0-90	11-1/4"	3/8-24
A-11355-000-0-92	11-1/2"	1/8 NPT
A-11356-000-0-92	11-1/2"	3/8-24
A-11355-000-0-94	11-3/4"	1/8 NPT
A-11356-000-0-94	11-3/4"	3/8-24
A-11355-000-0-96	12"	1/8 NPT
A-11356-000-0-96	12"	3/8-24

Adapter, Pipe Clamp

This adapter can be used with thermocouples with bayonet lock to measure tube or pipe surface temperatures. The thermocouple is in direct contact with pipe.

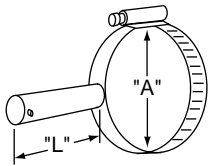

Part Number	"A" Dimension	"L" Dimension
A-05915-100-0-00	13/16 to 1-1/2"	1-1/2"
A-05915-200-0-00	13/16 to 1-1/2"	2"
A-05915-300-0-00	13/16 to 1-1/2"	2-1/2"
A-05915-400-0-00	13/16 to 1-1/2"	3"
A-05915-500-0-00	13/16 to 1-1/2"	3-1/2"
A-05915-600-0-00	13/16 to 1-1/2"	4"
A-05915-700-0-00	13/16 to 1-1/2"	4-1/2"
A-05916-100-0-00	1-9/16 to 2-1/2"	1-1/2"
A-05916-200-0-00	1-9/16 to 2-1/2"	2"
A-05916-300-0-00	1-9/16 to 2-1/2"	2-1/2"
A-05916-400-0-00	1-9/16 to 2-1/2"	3"
A-05916-500-0-00	1-9/16 to 2-1/2"	3-1/2"
A-05916-600-0-00	1-9/16 to 2-1/2"	4"
A-05916-700-0-00	1-9/16 to 2-1/2"	4-1/2"
A-05917-100-0-00	2-9/16 to 3-1/2"	1-1/2"
A-05917-200-0-00	2-9/16 to 3-1/2"	2"
A-05917-300-0-00	2-9/16 to 3-1/2"	2-1/2"
A-05917-400-0-00	2-9/16 to 3-1/2"	3"
A-05917-500-0-00	2-9/16 to 3-1/2"	3-1/2"
A-05917-600-0-00	2-9/16 to 3-1/2"	4"
A-05917-700-0-00	2-9/16 to 3-1/2"	4-1/2"
A-05918-100-0-00	3-9/16 to 4-1/2"	1-1/2"
A-05918-200-0-00	3-9/16 to 4-1/2"	2"
A-05918-300-0-00	3-9/16 to 4-1/2"	2-1/2"
A-05918-400-0-00	3-9/16 to 4-1/2"	3"
A-05918-500-0-00	3-9/16 to 4-1/2"	3-1/2"
A-05918-600-0-00	3-9/16 to 4-1/2"	4"
A-05918-700-0-00	3-9/16 to 4-1/2"	4-1/2"